

HITACHI

ZX75US-7 | ZX85USB-7 | Preliminary ZAXIS-7 series

Reliable Solutions



ZAXIS 75

ZAXIS 85

HYDRAULIC EXCAVATOR

Model code: ZX75US-7

Engine rated power, net: 67.6 hp (50.4 kW)

Operating weight: 18,100–19,800 lb. (8,216–8,984 kg)

Bucket capacity: 0.37 yd³ (0.28 m³)

Model code: ZX85USB-7

Engine rated power, net: 67.6 hp (50.4 kW)

Operating weight: Mono boom, 19,100–20,800 lb. (8,656–9,424 kg)

2-Piece boom, 20,000–21,700 lb. (9,066–9,834 kg)

Bucket capacity: 0.37 yd³ (0.28 m³)

SPECIFICATIONS

ENGINE	
Model	Yanmar 4TNV98CT
Type	4-cycle water-cooled, common rail direct injection exhaust turbo charger
Aspiration	Cooled EGR
Aftertreatment	Muffler filter
No. of cylinders	4
Rated power	
ISO 14396: 2002 gross	67.6 hp (50.4 kW) at 2,000 min ⁻¹
ISO 9249: 2007 net	63.7 hp (47.5 kW) at 2,000 min ⁻¹
Maximum torque	211 lbf (285.4 Nm) at 1,300 min ⁻¹
Piston displacement	202.5 cu.in. (3.318 L)
Bore and stroke	3.9" x 4.3" (98 mm x 110 mm)
Batteries	2 x 12 V / 60 Ah

HYDRAULIC SYSTEM				
Hydraulic Pumps				
Main pumps	3 variable displacement axial piston pumps			
Maximum oil flow	2 x 19 gal/min (72 L/min)			
	1 x 15 gal/min (56 L/min)			
Pilot pump	1 gear pump			
Maximum oil flow	5.0 gal/min (20.0 L/min)			
Hydraulic Motors				
Travel	2 variable displacement axial piston motors			
Swing	1 axial piston motor			
Relief Valve Settings				
Implement circuit	4,061 psi (28.0 MPa)			
Swing circuit	3,844 psi (26.5 MPa)			
Travel circuit	4,554 psi (31.4 MPa)			
Pilot circuit	566 psi (3.9 MPa)			
Hydraulic Cylinders				
ZX75US-7				
	Quantity	Bore	Rod diameter	Stroke
Boom	1	4.5" (115 mm)	2.8" (70 mm)	34.8" (885 mm)
Arm	1	3.7" (95 mm)	2.4" (60 mm)	35.4" (900 mm)
Bucket	1	3.3" (85 mm)	2.2" (55 mm)	28.7" (730 mm)
Blade	1	4.7" (120 mm)	2.8" (70 mm)	5.7" (145 mm)
ZX85USB-7				
	Quantity	Bore	Rod diameter	Stroke
Boom	1	4.5" (115 mm)	2.8" (70 mm)	36.0" (915 mm)
Arm	1	3.7" (95 mm)	2.4" (60 mm)	35.4" (900 mm)
Bucket	1	3.3" (85 mm)	2.2" (55 mm)	28.7" (730 mm)
Blade	1	4.7" (120 mm)	2.8" (70 mm)	5.7" (145 mm)
Boom swing	1	4.3" (110 mm)	2.4" (60 mm)	22.2" (563 mm)
Positioning*1	2	4.3" (110 mm)	2.4" (60 mm)	17.0" (432 mm)

*1: For 2-Piece boom

UPPERSTRUCTURE	
Revolving Frame	
D-section frame for resistance to deformation	
Swing Device	
Axial piston motor with planetary reduction gear is bathed in oil. Swing circle is single-row. Swing parking brake is spring-set/hydraulic-released disc type.	
Swing speed	10.1 min ⁻¹
Swing torque	12,243 lbf (16.6 kNm)
Operator's Cab	
Independent spacious cab, 3' 4" (1,025 mm) wide by 5' 5" (1,654 mm) high, conforming to ISO* Standards. Reinforced glass windows on 4 sides for visibility. Front windows (upper and lower) can be opened. Reclining seat.	
* International Organization for Standardization	

UNDERCARRIAGE	
Tracks	
Tractor-type undercarriage. Welded track frame using selected materials. Side frame welded to track frame	
Numbers of Rollers and Shoes on Each Side	
Upper rollers	1
Lower rollers	5
Track shoes	40
Travel Device	
Each track driven by 2-speed axial piston motor. Parking brake is spring-set/hydraulic-released disc type. Automatic transmission system: High-Low.	
Travel speeds	High: 0 to 3.1 mph (0 to 5.0 km/h)
	Low: 0 to 1.9 mph (0 to 3.1 km/h)
Maximum traction force	14,660 lbf (65.2 kN)
Gradeability	70% (35 degree) continuous

SERVICE REFILL CAPACITIES	
Fuel tank	33.0 gal (125.0 L)
Engine coolant	3.5 gal (13.1 L)
Engine oil	3.2 gal (12.3 L)
Travel device (each side)	0.3 gal (1.2 L)
Hydraulic system	26.4 gal (100.0 L)
Hydraulic oil tank	13.7 gal (52.0 L)

WEIGHTS AND GROUND PRESSURE

Operating Weight and Ground Pressure

			ZX75US-7	
Boom type			Monoblock	
Shoe type	Shoe width, in (mm)	Arm length, ft-in (m)	lb (kg)	psi (kPa)
Grouser shoe	18" (450)	5' 4" (1.62 m)	18,300 (8,310)	5.4 (37)
		6' 11" (2.12 m)	18,500 (8,380)	5.4 (37)
	24" (600)	5' 4" (1.62 m)	18,700 (8,484)	4.1 (28)
		6' 11" (2.12 m)	18,900 (8,554)	4.2 (29)
Rubber shoe	18" (450)	5' 4" (1.62 m)	18,100 (8,216)	5.4 (37)
		6' 11" (2.12 m)	18,300 (8,286)	5.4 (37)
Pad crawler shoe	18" (450)	5' 4" (1.62 m)	18,500 (8,384)	5.4 (37)
		6' 11" (2.12 m)	18,600 (8,418)	5.4 (37)

Including 0.37 yd³ (0.28 m³) (ISO 7451: 2007 heaped) bucket weight 465 lb (211 kg) and counterweight 2,568 lb (1,165 kg).

			ZX85USB-7			
Boom type			Monoblock		2-Piece	
Shoe type	Shoe width, in (mm)	Arm length, ft-in (m)	lb (kg)	psi (kPa)	lb (kg)	psi (kPa)
Grouser shoe	18" (450)	5' 4" (1.62 m)	19,300 (8,750)	5.7 (39)	20,200 (9,160)	5.9 (41)
		6' 11" (2.12 m)	19,400 (8,820)	5.7 (39)	20,300 (9,230)	5.9 (41)
	24" (600)	5' 4" (1.62 m)	19,700 (8,924)	4.4 (30)	20,600 (9,334)	4.5 (31)
		6' 11" (2.12 m)	19,800 (8,994)	4.4 (30)	20,700 (9,404)	4.5 (31)
Rubber shoe	18" (450)	5' 4" (1.62 m)	19,100 (8,656)	5.7 (39)	20,000 (9,066)	5.8 (40)
		6' 11" (2.12 m)	19,200 (8,726)	5.7 (39)	20,100 (9,136)	5.9 (41)
Pad crawler shoe	18" (450)	5' 4" (1.62 m)	19,400 (8,788)	5.7 (39)	20,300 (9,198)	5.9 (41)
		6' 11" (2.12 m)	19,500 (8,858)	5.7 (39)	20,400 (9,268)	5.9 (41)

Including 0.37 yd³ (0.28 m³) (ISO 7451: 2007 heaped) bucket weight 465 lb (211 kg) and counterweight 2,568 lb (1,165 kg).

BUCKET AND ARM DIGGING FORCE

Unit: lbf (kN)

Arm length	ZX75US-7		ZX85USB-7	
	5' 4" (1.62 m)	6' 11" (2.12 m)	5' 4" (1.62 m)	6' 11" (2.12 m)
Bucket digging force* ISO 6015: 2006	12,926.5 (57.5)	12,926.5 (57.5)	12,926.5 (57.5)	12,926.5 (57.5)
Bucket digging force SAE: PCSA	11,262.9 (50.1)	11,262.9 (50.1)	11,262.9 (50.1)	11,262.9 (50.1)
Arm crowd force* ISO 6015: 2006	9,037.3 (40.2)	7,755.9 (34.5)	9,037.3 (40.2)	7,755.9 (34.5)
Arm crowd force SAE: PCSA	8,565.2 (38.1)	7,418.7 (33.0)	8,565.2 (38.1)	7,418.7 (33.0)

* At power boost

SPECIFICATIONS

ZX75US-7

WORKING RANGES

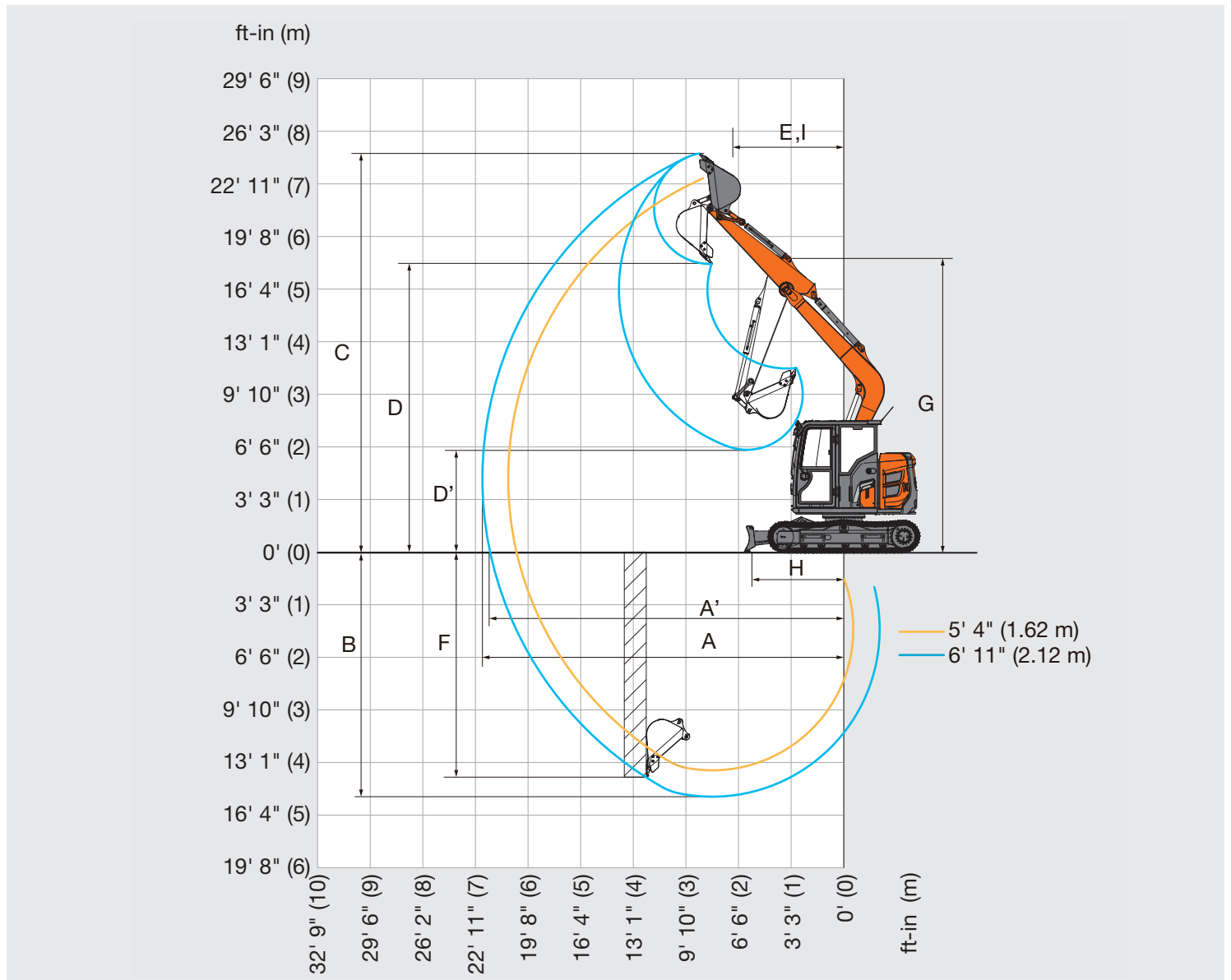

Unit: ft-in (mm)

	ZX75US-7	
	Monoblock boom	
Arm length	5' 4" (1.62 m)	6' 11" (2.12 m)
A Max. digging reach	20' 11" (6,380)	22' 6" (6,870)
A' Max. digging reach (on ground)	20' 5" (6,220)	22' 1" (6,720)
B Max. digging depth	13' 7" (4,150)	15' 3" (4,650)
C Max. cutting height	23' 7" (7,180)	24' 10" (7,580)
D Max. dumping height	16' 8" (5,080)	17' 12" (5,480)
D' Min. dumping height	7' 9" (2,360)	6' 5" (1,950)
E Min. swing radius	5' 9" (1,760)	6' 11" (2,120)
F Max. vertical wall digging depth	12' 3" (3,730)	13' 12" (4,260)
G Front height at Min. swing radius	18' 3" (5,550)	18' 3" (5,570)
H Min. level crowding distance	5' 8" (1,720)	5' 4" (1,630)
I Working radius at Min. swing radius (Max. boom-swing angle)	5' 9" (1,760)	6' 11" (2,120)

Excluding track shoe lug

DIMENSIONS

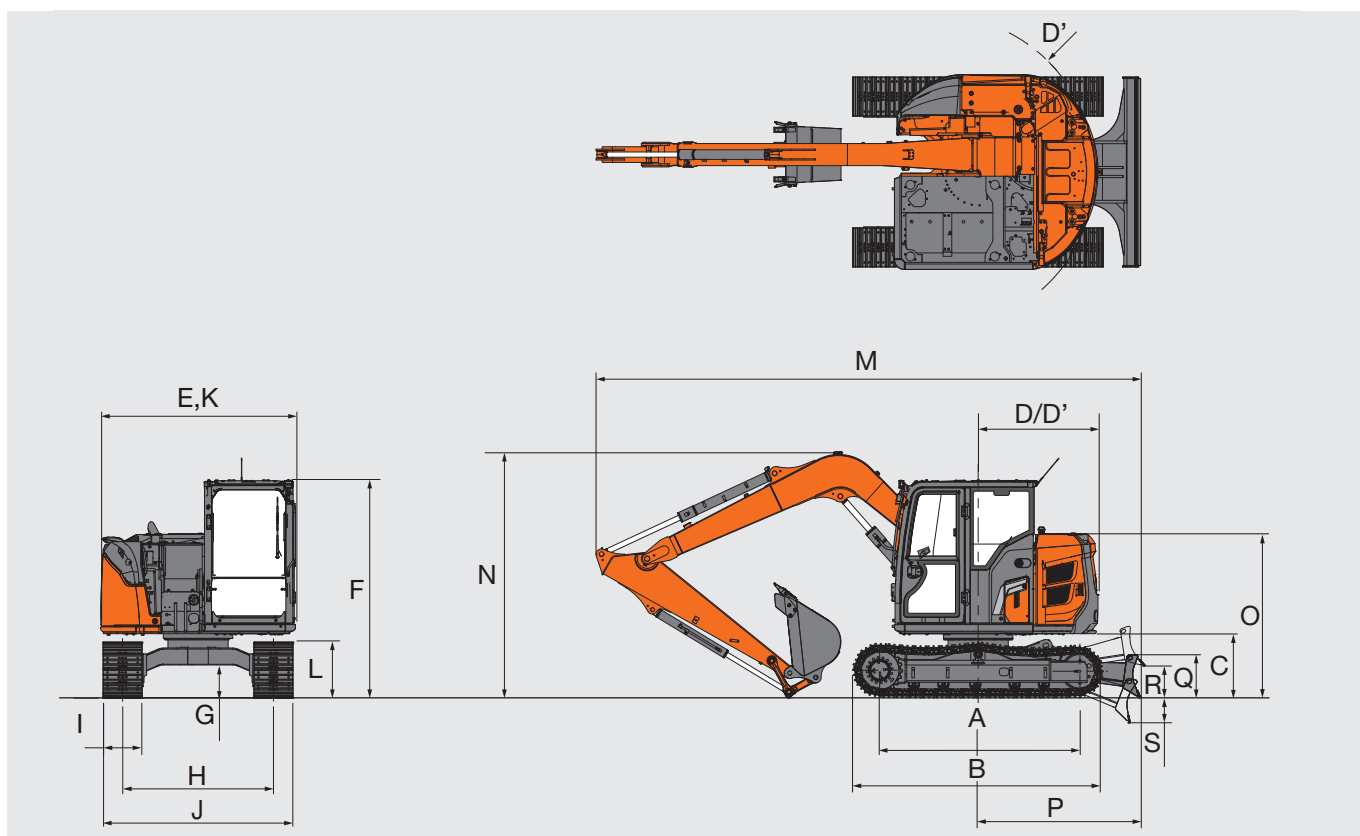

Unit: ft-in (mm)

		ZX75US-7
		Monoblock boom
A	Distance between tumblers	7' 6" (2,295)
B	Undercarriage length	9' 6" (2,900)
C	Counterweight clearance	2' 4" (720)
D	Rear-end swing radius	4' 7" (1,390)
D'	Rear-end length	4' 7" (1,390)
E	Overall width of upperstructure	7' 5" (2,260)
F	Overall height of cab	8' 4" (2,530)
G	Min. ground clearance	1' 2" (360)
H	Track gauge	5' 9" (1,750)
I	Track shoe width	6' 1" (450)
J	Undercarriage width	7' 3" (2,200)
K	Overall width	7' 5" (2,260)
L	Track height	2' 0" (610)
M	Overall length	with 5' 4" (1.62 m) arm
		with 6' 11" (2.12 m) arm
N	Overall height of boom	with 5' 4" (1.62 m) arm
		with 6' 11" (2.12 m) arm
O	Engine cover-height	6' 2" (1,880)
P	Distance between the front end of blade and the axis of rotation	6' 2" (1,890)
Q	Blade height	1' 7" (472)
R	Blade bottom highest position above ground	1' 3" (390)
S	Blade bottom lowest position above ground	1' 1" (340)

* Excluding track shoe lug G: Grouser shoe

SPECIFICATIONS

ZX85USB-7

WORKING RANGES

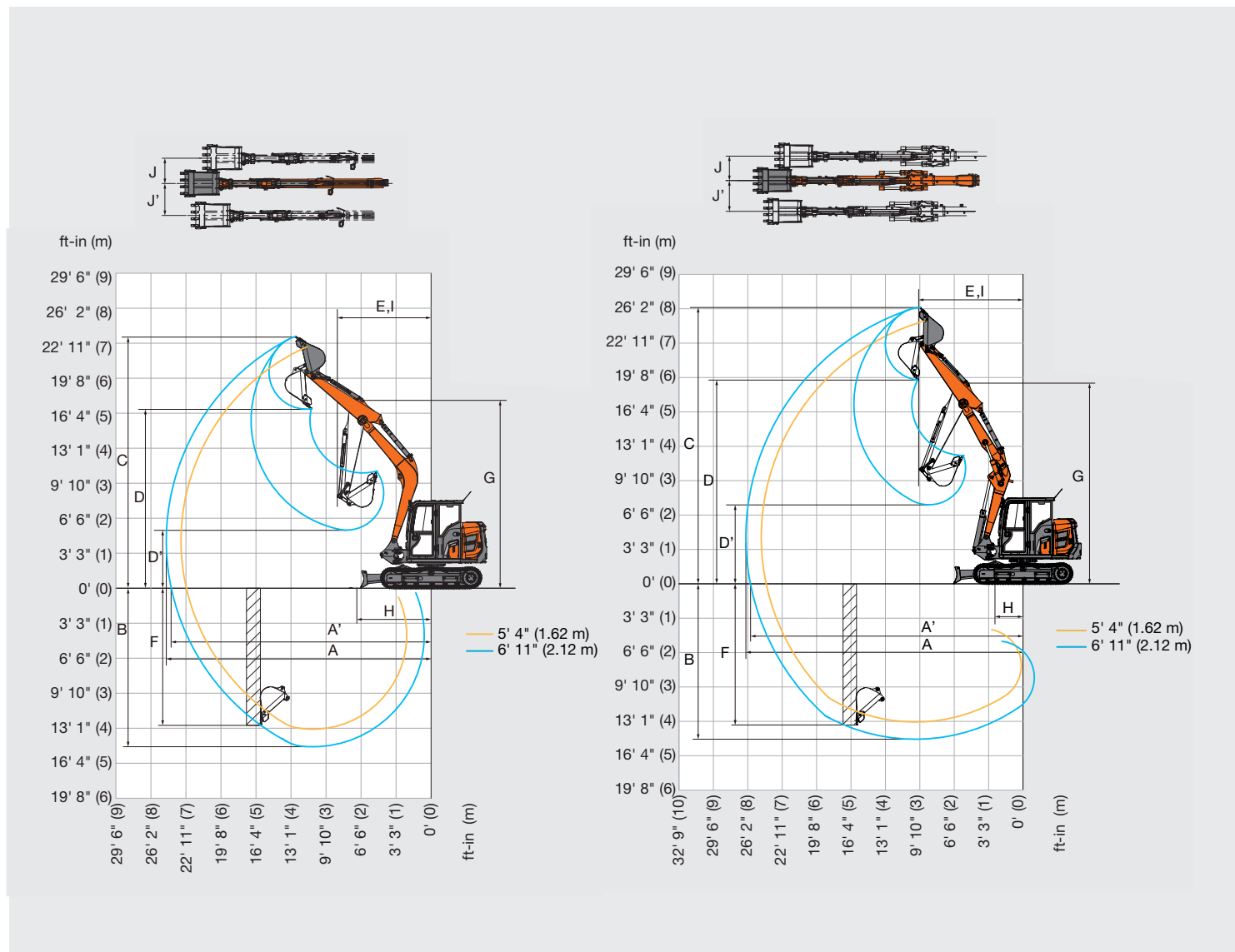

Unit: ft-in (mm)

	ZX85USB-7			
	Monoblock boom		2-Piece boom	
Arm length	5' 4" (1.62 m)	6' 11" (2.12 m)	5' 4" (1.62 m)	6' 11" (2.12 m)
A Max. digging reach	23' 5" (7,140)	24' 10" (7,560)	24' 12" (7,610)	26' 5" (8,060)
A' Max. digging reach (on ground)	22' 11" (6,990)	24' 4" (7,420)	24' 6" (7,470)	25' 12" (7,920)
B Max. digging depth	13' 3" (4,030)	14' 10" (4,530)	12' 4" (3,760)	13' 12" (4,260)
C Max. cutting height	22' 10" (6,960)	23' 7" (7,190)	25' 3" (7,690)	26' 5" (8,040)
D Max. dumping height	15' 12" (4,870)	16' 10" (5,120)	18' 4" (5,590)	19' 5" (5,930)
D' Min. dumping height	7' 0" (2,140)	5' 5" (1,660)	8' 11" (2,730)	7' 7" (2,300)
E Min. swing radius	8' 4" (2,530)	8' 10" (2,680)	9' 0" (2,750)	9' 11" (3,020)
F Max. vertical wall digging depth	11' 10" (3,600)	12' 10" (3,900)	11' 12" (3,650)	13' 6" (4,110)
G Front height at Min. swing radius	17' 6" (5,330)	17' 7" (5,350)	19' 1" (5,810)	19' 2" (5,830)
H Min. level crowding distance	7' 12" (2,430)	7' 0" (2,140)	3' 3" (990)	2' 4" (720)
I Working radius at Min. swing radius (Max. boom-swing angle)	6' 10" (2,080)	7' 3" (2,210)	6' 10" (2,080)	7' 3" (2,210)
J Offset distance (Max. boom-swing angle)	2' 10" (860)	2' 10" (860)	2' 10" (860)	2' 10" (860)
J' Offset distance (Max. boom-swing angle)	2' 5" (730)	2' 5" (730)	2' 5" (730)	2' 5" (730)
Max. boom-swing angle (deg.)	65 /55	65 /55	65 /55	65 /55

Excluding track shoe lug

DIMENSIONS

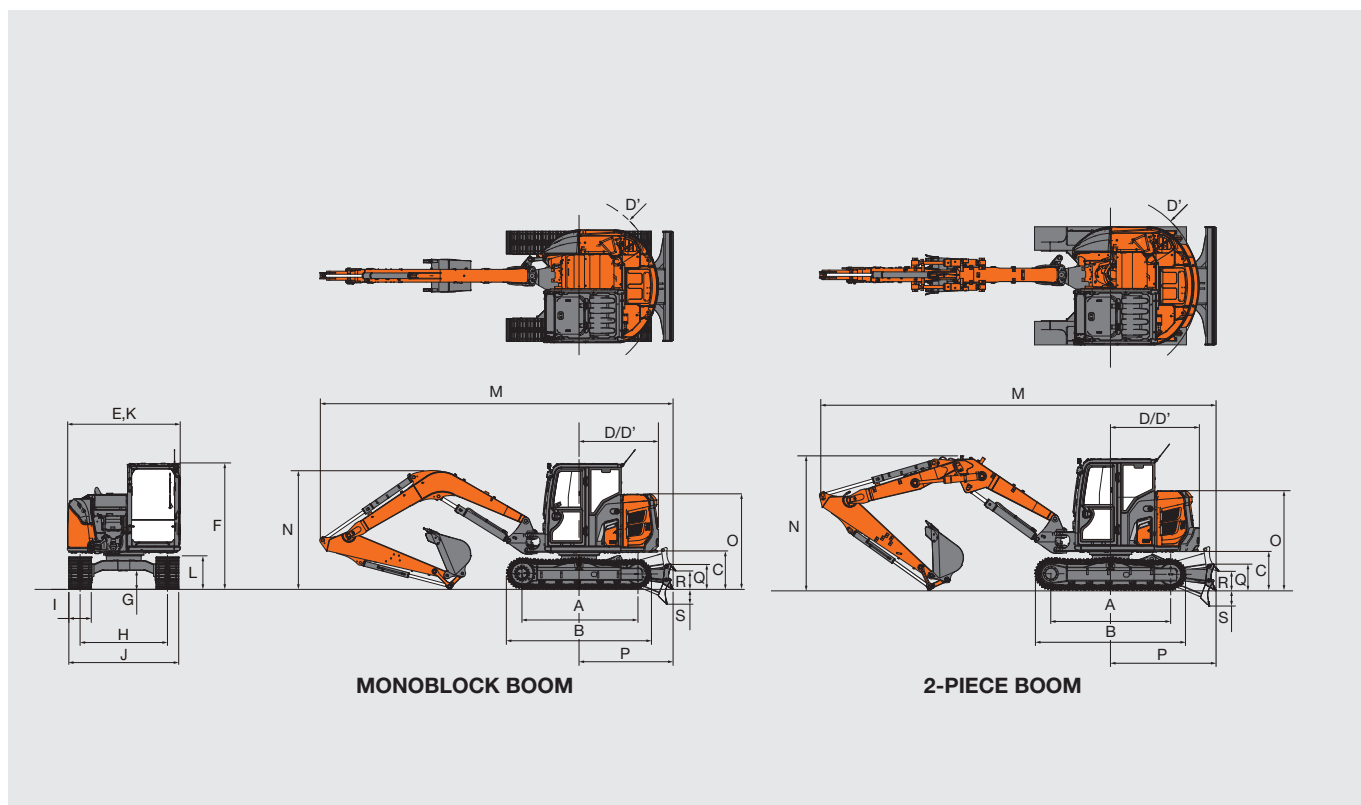

Unit: ft-in (mm)

		ZX85USB-7	
		Monoblock boom	2-Piece boom
A	Distance between tumbler	7' 6" (2,295)	7' 6" (2,295)
B	Undercarriage length	9' 6" (2,900)	9' 6" (2,900)
C	Counterweight clearance	2' 4" (720)	2' 4" (720)
D	Rear-end swing radius	5' 3" (1,590)	5' 3" (1,590)
D'	Rear-end length	5' 3" (1,590)	5' 3" (1,590)
E	Overall width of upperstructure	7' 5" (2,260)	7' 5" (2,260)
F	Overall height of cab	8' 4" (2,530)	8' 4" (2,530)
G	Min. ground clearance	1' 2" (360)	1' 2" (360)
H	Track gauge	5' 9" (1,750)	5' 9" (1,750)
I	Track shoe width	G 1' 6" (450)	G 1' 6" (450)
J	Undercarriage width	7' 3" (2,200)	7' 3" (2,200)
K	Overall width	7' 5" (2,260)	7' 5" (2,260)
L	Track height	2' 0" (610)	2' 0" (610)
M	Overall length		
	With 5' 4" (1.62 m) arm	23' 4" (7,120)	24' 12" (7,610)
	With 6' 11" (2.12 m) arm	23' 8" (7,220)	24' 11" (7,600)
N	Overall height of boom		
	With 5' 4" (1.62 m) arm	8' 4" (2,530)	8' 4" (2,530)
	With 6' 11" (2.12 m) arm	8' 4" (2,530)	9' 1" (2,780)
O	Engine cover-height	6' 2" (1,880)	6' 2" (1,880)
P	Distance between the front end of blade and the axis of rotation	6' 7" (2,010)	6' 7" (2,010)
Q	Blade height	1' 7" (472)	1' 7" (472)
R	Blade bottom highest position above ground	1' 3" (390)	1' 3" (390)
S	Blade bottom lowest position above ground	1' 1" (340)	1' 1" (340)

* Excluding track shoe lug G: Grouser shoe

MACHINE CAPACITIES

ZX75US-7

- Notes:
1. Ratings are based on ISO 10567: 2007.
 2. Machine capacity does not exceed 75% of tipping load with the machine on firm, level ground or 87% full hydraulic capacity.
 3. The load point is the center-line of the bucket pivot mounting pin on the arm.
 4. *Indicates load limited by hydraulic capacity. 0 ft (0 m) = Ground. To determine lifting capacities, apply "Rating over-side or 360 degrees" machine capacities from table with "Blade above Ground" and deduct weight of installed attachment and quick hitch.

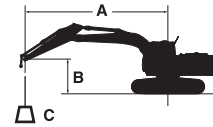

- A: Load radius
 B: Load point height
 C: Machine capacity











ZX75US-7 Monoblock boom, Blade above Ground

Rating over-front Rating over-side or 360 degrees Unit: lb (kg)

Conditions	Load point height (ft (m))	Load radius								At max. reach		
		5 ft (1.5 m)		10 ft (3.0 m)		15 ft (4.5 m)		20 ft (6.0 m)				ft-in (meter)
Boom 12' 2" (3.72 m) Arm 5' 4" (1.62 m) Counterweight 2,568 lb (1,165 kg) Grouser shoe 18" (450 mm)	20' (6.0)											
	15' (4.5)			3,790* (1,720)*	3,790* (1,720)*					3,640* (1,650)*	3,640* (1,650)*	13' 11" (4.24)
	10' (3.0)			5,120* (2,320)*	5,120* (2,320)*	4,220 (1,910)	3,430 (1,550)			3,470* (1,570)*	2,910 (1,320)	16' 7" (5.05)
	5' (1.5)			7,290* (3,310)*	5,830 (2,640)	4,040 (1,830)	3,260 (1,480)			3,210 (1,450)	2,610 (1,180)	17' 5" (5.32)
	0 (Ground)			7,200 (3,260)	5,530 (2,500)	3,900 (1,770)	3,130 (1,420)			3,320 (1,500)	2,680 (1,210)	16' 10" (5.12)
	-5' (-1.5)	10,590* (4,800)*	10,590* (4,800)*	7,180 (3,250)	5,500 (2,490)					4,100 (1,860)	3,280 (1,480)	14' 6" (4.41)
	-10' (-3.0)									5,310* (2,400)*	5,310* (2,400)*	9' 2" (2.80)
	-15' (-4.5)											
Boom 12' 2" (3.72 m) Arm 6' 11" (2.12 m) Counterweight 2,568 lb (1,165 kg) Grouser shoe 18" (450 mm)	20' (6.0)											
	15' (4.5)					3,440* (1,560)*	3,440* (1,560)*			3,030* (1,370)*	3,030* (1,370)*	15' 11" (4.84)
	10' (3.0)			4,200* (1,900)*	4,200* (1,900)*	3,710* (1,680)*	3,440 (1,560)			2,900* (1,310)*	2,470 (1,120)	18' 3" (5.56)
	5' (1.5)			6,490* (2,940)*	5,890 (2,670)	4,030 (1,820)	3,240 (1,470)			2,770 (1,250)	2,240 (1,010)	19' 1" (5.81)
	0 (Ground)			7,140 (3,240)	5,460 (2,470)	3,840 (1,740)	3,060 (1,390)			2,830 (1,280)	2,270 (1,030)	18' 6" (5.63)
	-5' (-1.5)	8,400* (3,810)*	8,400* (3,810)*	7,020 (3,180)	5,350 (2,430)	3,780 (1,710)	3,000 (1,360)			3,340 (1,510)	2,670 (1,210)	16' 4" (4.99)
	-10' (-3.0)	11,460* (5,200)*	11,460* (5,200)*	6,290* (2,850)*	5,510 (2,500)					4,880* (2,210)*	4,250 (1,920)	11' 12" (3.65)
	-15' (-4.5)											

ZX75US-7 Monoblock boom, Blade above Ground

 Rating over-front  Rating over-side or 360 degrees Unit: lb (kg)

Conditions	Load point height (ft (m))	Load radius								At max. reach		
		5 ft (1.5 m)		10 ft (3.0 m)		15 ft (4.5 m)		20 ft (6.0 m)				ft-in (meter)
												
Boom 12' 2" (3.72 m) Arm 5' 4" (1.62 m) Counterweight 3,516 lb (1,595 kg) Grouser shoe 18" (450 mm)	20' (6.0)											
	15' (4.5)			3,790* (1,720)*	3,790* (1,720)*					3,640* (1,650)*	3,640* (1,650)*	13' 11" (4.24)
	10' (3.0)			5,120* (2,320)*	5,120* (2,320)*	4,250* (1,930)*	3,870 (1,750)			3,470* (1,570)*	3,310 (1,500)	16' 7" (5.05)
	5' (1.5)			7,290* (3,310)*	6,600 (2,990)	4,570 (2,070)	3,710 (1,680)			3,640 (1,650)	2,980 (1,350)	17' 5" (5.32)
	0 (Ground)			8,150 (3,690)	6,300 (2,850)	4,430 (2,010)	3,580 (1,620)			3,770 (1,710)	3,060 (1,390)	16' 10" (5.12)
	-5' (-1.5)	10,590* (4,800)*	10,590* (4,800)*	7,850* (3,560)*	6,270 (2,840)					4,650 (2,100)	3,750 (1,700)	14' 6" (4.41)
	-10' (-3.0)									5,310* (2,400)*	5,310* (2,400)*	9' 2" (2.80)
	-15' (-4.5)											
Boom 12' 2" (3.72 m) Arm 6' 11" (2.12 m) Counterweight 3,516 lb (1,595 kg) Grouser shoe 18" (450 mm)	20' (6.0)											
	15' (4.5)					3,440* (1,560)*	3,440* (1,560)*			3,030* (1,370)*	3,030* (1,370)*	15' 11" (4.84)
	10' (3.0)			4,200* (1,900)*	4,200* (1,900)*	3,710* (1,680)*	3,710* (1,680)*			2,900* (1,310)*	2,820 (1,280)	18' 3" (5.56)
	5' (1.5)			6,490* (2,940)*	6,490 (2,940)	4,480* (2,030)*	3,690 (1,670)			3,030* (1,370)*	2,570 (1,160)	19' 1" (5.81)
	0 (Ground)			7,980* (3,620)*	6,230 (2,820)	4,360 (1,980)	3,510 (1,590)			3,230 (1,460)	2,620 (1,190)	18' 6" (5.63)
	-5' (-1.5)	8,400* (3,810)*	8,400* (3,810)*	7,970 (3,610)	6,120 (2,780)	4,300 (1,950)	3,450 (1,560)			3,810 (1,720)	3,070 (1,390)	16' 4" (4.99)
	-10' (-3.0)	11,460* (5,200)*	11,460* (5,200)*	6,290* (2,850)*	6,280 (2,850)					4,880* (2,210)*	4,850 (2,200)	11' 12" (3.65)
	-15' (-4.5)											

MACHINE CAPACITIES

ZX85US-7

- Notes:
1. Ratings are based on ISO 10567: 2007.
 2. Machine capacity does not exceed 75% of tipping load with the machine on firm, level ground or 87% full hydraulic capacity.
 3. The load point is the center-line of the bucket pivot mounting pin on the arm.
 4. *Indicates load limited by hydraulic capacity. 0 ft (0 m) = Ground. To determine lifting capacities, apply "Rating over-side or 360 degrees" machine capacities from table with "Blade above Ground" and deduct weight of installed attachment and quick hitch.

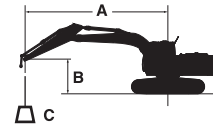

- A: Load radius
 B: Load point height
 C: Machine capacity











ZX85USB-7 Monoblock boom, Blade above Ground

Rating over-front Rating over-side or 360 degrees Unit: lb (kg)

Conditions	Load point height (ft (m))	Load radius								At max. reach		
		5 ft (1.5 m)		10 ft (3.0 m)		15 ft (4.5 m)		20 ft (6.0 m)				ft-in (meter)
Boom 11' 7" (3.55 m) Arm 5' 4" (1.62 m) Counterweight 2,568 lb (1,165 kg) Grouser shoe 18" (450 mm)	20' (6.0)											
	15' (4.5)											
	10' (3.0)			7,950* (3,600)*	6,660 (3,020)	4,430 (2,010)	3,610 (1,630)			3,050 (1,380)	2,500 (1,130)	18' 12" (5.79)
	5' (1.5)					4,190 (1,900)	3,380 (1,530)			2,760 (1,250)	2,260 (1,020)	19' 11" (6.08)
	0 (Ground)			6,210* (2,810)*	5,660 (2,560)	4,020 (1,820)	3,230 (1,460)			2,830 (1,280)	2,310 (1,040)	19' 4" (5.89)
	-5' (-1.5)			7,430 (3,370)	5,710 (2,590)	4,010 (1,820)	3,220 (1,460)			3,400 (1,540)	2,750 (1,240)	16' 12" (5.17)
	-10' (-3.0)											
-15' (-4.5)												
Boom 11' 7" (3.55 m) Arm 6' 11" (2.12 m) Counterweight 2,568 lb (1,165 kg) Grouser shoe 18" (450 mm)	20' (6.0)											
	15' (4.5)					4,180* (1,890)*	3,750 (1,700)			3,400 (1,540)	2,780 (1,260)	17' 11" (5.45)
	10' (3.0)					4,440 (2,010)	3,620 (1,640)	2,790 (1,260)	2,280 (1,030)	2,690 (1,220)	2,190 (990)	20' 5" (6.23)
	5' (1.5)			7,680 (3,480)	5,920 (2,680)	4,170 (1,890)	3,360 (1,520)	2,710 (1,230)	2,200 (1,000)	2,450 (1,110)	1,990 (900)	21' 4" (6.50)
	0 (Ground)			7,230 (3,280)	5,520 (2,500)	3,940 (1,790)	3,150 (1,420)	2,620 (1,190)	2,120 (960)	2,490 (1,130)	2,010 (910)	20' 9" (6.33)
	-5' (-1.5)	6,870* (3,110)*	6,870* (3,110)*	7,220 (3,270)	5,510 (2,500)	3,880 (1,760)	3,090 (1,400)			2,880 (1,300)	2,320 (1,050)	18' 7" (5.67)
	-10' (-3.0)			7,170 (3,250)	5,700 (2,580)					4,440 (2,010)	3,540 (1,600)	13' 11" (4.25)
-15' (-4.5)												

ZX85USB-7 Monoblock boom, Blade above Ground

 Rating over-front  Rating over-side or 360 degrees Unit: lb (kg)

Conditions	Load point height (ft (m))	Load radius								At max. reach		
		5 ft (1.5 m)		10 ft (3.0 m)		15 ft (4.5 m)		20 ft (6.0 m)				ft-in (meter)
												
Boom 11' 7" (3.55 m) Arm 5' 4" (1.62 m) Counterweight 3,516 lb (1,595 kg) Grouser shoe 18" (450 mm)	20' (6.0)											
	15' (4.5)											
	10' (3.0)			7,950* (3,600)*	7,490 (3,400)	4,990 (2,260)	4,100 (1,860)			3,470 (1,570)	2,870 (1,300)	18' 12" (5.79)
	5' (1.5)					4,750 (2,150)	3,870 (1,750)			3,160 (1,430)	2,600 (1,180)	19' 11" (6.08)
	0 (Ground)			6,210* (2,810)*	6,210* (2,810)*	4,590 (2,080)	3,720 (1,680)			3,240 (1,470)	2,660 (1,210)	19' 4" (5.89)
	-5' (-1.5)			8,450 (3,830)	6,550 (2,970)	4,570 (2,070)	3,700 (1,680)			3,880 (1,760)	3,170 (1,430)	16' 12" (5.17)
	-10' (-3.0)											
-15' (-4.5)												
Boom 11' 7" (3.55 m) Arm 6' 11" (2.12 m) Counterweight 3,516 lb (1,595 kg) Grouser shoe 18" (450 mm)	20' (6.0)											
	15' (4.5)					4,180* (1,890)*	4,180* (1,890)*			3,730* (1,690)*	3,180 (1,440)	17' 11" (5.45)
	10' (3.0)					4,840 (2,190)	4,100 (1,860)	3,190 (1,440)	2,630 (1,190)	3,070 (1,390)	2,530 (1,140)	20' 5" (6.23)
	5' (1.5)			8,700 (3,940)	6,760 (3,060)	4,730 (2,140)	3,840 (1,740)	3,100 (1,400)	2,540 (1,150)	2,810 (1,270)	2,310 (1,040)	21' 4" (6.50)
	0 (Ground)			7,290* (3,300)*	6,350 (2,880)	4,510 (2,040)	3,630 (1,650)	3,020 (1,360)	2,460 (1,110)	2,860 (1,290)	2,340 (1,060)	20' 9" (6.33)
	-5' (-1.5)	6,870* (3,110)*	6,870* (3,110)*	8,240 (3,740)	6,350 (2,880)	4,440 (2,010)	3,570 (1,620)			3,310 (1,500)	2,700 (1,220)	18' 7" (5.67)
	-10' (-3.0)			7,170* (3,250)*	6,540 (2,960)					4,490* (2,030)*	4,070 (1,840)	13' 11" (4.25)
-15' (-4.5)												

MACHINE CAPACITIES

ZX85US-7

- Notes:
1. Ratings are based on ISO 10567: 2007.
 2. Machine capacity does not exceed 75% of tipping load with the machine on firm, level ground or 87% full hydraulic capacity.
 3. The load point is the center-line of the bucket pivot mounting pin on the arm.
 4. *Indicates load limited by hydraulic capacity. 0 ft (0 m) = Ground. To determine lifting capacities, apply "Rating over-side or 360 degrees" machine capacities from table with "Blade above Ground" and deduct weight of installed attachment and quick hitch.

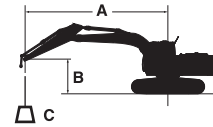

- A: Load radius
 B: Load point height
 C: Machine capacity











ZX85USB-7 2-Piece boom, Blade above Ground

Rating over-front Rating over-side or 360 degrees Unit: lb (kg)

Conditions	Load point height (ft (m))	Load radius								At max. reach			
		5 ft (1.5 m)		10 ft (3.0 m)		15 ft (4.5 m)		20 ft (6.0 m)				ft-in (meter)	
Boom 12' 11" (3.94 m) Arm 5' 4" (1.62 m) Counterweight 2,568 lb (1,165 kg) Grouser shoe 18" (450 mm)	20' (6.0)												
	15' (4.5)					4,500 (2,040)	3,620 (1,640)			3,190 (1,440)	2,560 (1,160)	18' 1" (5.51)	
	10' (3.0)					4,240 (1,920)	3,380 (1,530)	2,630 (1,190)	2,100 (950)	2,480 (1,120)	1,970 (890)	20' 8" (6.29)	
	5' (1.5)					3,840 (1,740)	3,000 (1,360)	2,510 (1,140)	1,980 (900)	2,240 (1,010)	1,760 (790)	21' 6" (6.55)	
	0 (Ground)					3,590 (1,630)	2,770 (1,250)	2,410 (1,090)	1,890 (850)	2,260 (1,020)	1,770 (800)	20' 11" (6.38)	
	-5' (-1.5)			6,700 (3,040)	4,970 (2,250)	3,560 (1,610)	2,740 (1,240)			2,640 (1,190)	2,060 (930)	18' 10" (5.73)	
	-10' (-3.0)												
	-15' (-4.5)												
Boom 12' 11" (3.94 m) Arm 6' 11" (2.12 m) Counterweight 2,568 lb (1,165 kg) Grouser shoe 18" (450 mm)	20' (6.0)												
	15' (4.5)					4,550* (2,060)*	3,700 (1,670)			2,710 (1,230)	2,170 (980)	19' 10" (6.05)	
	10' (3.0)			8,040* (3,640)*	6,570 (2,980)	4,300 (1,950)	3,430 (1,550)	2,640 (1,200)	2,100 (950)	2,170 (980)	1,710 (770)	22' 2" (6.76)	
	5' (1.5)					3,850 (1,740)	3,010 (1,360)	2,480 (1,120)	1,950 (880)	1,960 (890)	1,530 (690)	22' 12" (7.00)	
	0 (Ground)					3,520 (1,590)	2,700 (1,220)	2,340 (1,060)	1,810 (820)	1,970 (890)	1,520 (690)	22' 5" (6.84)	
	-5' (-1.5)			6,440 (2,920)	4,720 (2,140)	3,420 (1,550)	2,610 (1,180)	2,300 (1,040)	1,780 (800)	2,230 (1,010)	1,720 (780)	20' 6" (6.25)	
	-10' (-3.0)												
	-15' (-4.5)												

ZX85USB-7 2-Piece boom, Blade above Ground

 Rating over-front  Rating over-side or 360 degrees Unit: lb (kg)

Conditions	Load point height (ft (m))	Load radius								At max. reach		
		5 ft (1.5 m)		10 ft (3.0 m)		15 ft (4.5 m)		20 ft (6.0 m)				ft-in (meter)
												
Boom 12' 11" (3.94 m) Arm 5' 4" (1.62 m) Counterweight 3,516 lb (1,595 kg) Grouser shoe 18" (450 mm)	20' (6.0)											
	15' (4.5)					5,060 (2,290)	4,110 (1,860)			3,630 (1,640)	2,940 (1,330)	18' 1" (5.51)
	10' (3.0)					4,800 (2,180)	3,870 (1,750)	3,020 (1,370)	2,440 (1,100)	2,860 (1,290)	2,300 (1,040)	20' 8" (6.29)
	5' (1.5)					4,400 (1,990)	3,490 (1,580)	2,910 (1,310)	2,330 (1,050)	2,590 (1,170)	2,070 (940)	21' 6" (6.55)
	0 (Ground)					4,150 (1,880)	3,260 (1,480)	2,800 (1,270)	2,230 (1,010)	2,630 (1,190)	2,100 (950)	20' 11" (6.38)
	-5' (-1.5)			7,490* (3,400)*	5,810 (2,630)	4,120 (1,870)	3,230 (1,460)			3,060 (1,380)	2,430 (1,100)	18' 10" (5.73)
	-10' (-3.0)											
	-15' (-4.5)											
Boom 12' 11" (3.94 m) Arm 6' 11" (2.12 m) Counterweight 3,516 lb (1,595 kg) Grouser shoe 18" (450 mm)	20' (6.0)											
	15' (4.5)					4,550* (2,060)*	4,180 (1,890)			3,110 (1,410)	2,510 (1,140)	19' 10" (6.05)
	10' (3.0)			8,040* (3,640)*	7,410 (3,360)	4,870 (2,200)	3,920 (1,780)	3,040 (1,370)	2,450 (1,110)	2,520 (1,140)	2,010 (910)	22' 2" (6.76)
	5' (1.5)					4,420 (2,000)	3,500 (1,580)	2,870 (1,300)	2,290 (1,040)	2,300 (1,040)	1,820 (820)	22' 12" (7.00)
	0 (Ground)					4,090 (1,850)	3,190 (1,440)	2,730 (1,240)	2,150 (970)	2,310 (1,050)	1,820 (820)	22' 5" (6.84)
	-5' (-1.5)			7,460 (3,380)	5,560 (2,520)	3,990 (1,810)	3,100 (1,400)	2,690 (1,220)	2,120 (960)	2,610 (1,180)	2,060 (930)	20' 6" (6.25)
	-10' (-3.0)											
	-15' (-4.5)											

EQUIPMENT

●: Standard equipment ○: Optional equipment –: Not applicable

ENGINE	ZX75US-7	ZX85USB-7
Aftertreatment device	●	●
Air cleaner double filters	●	●
Alternator 24 V - 60 A	●	●
Auto idle system	●	●
Auto shut-down control	●	●
Cartridge-type engine oil filter	●	●
Cartridge-type fuel main filter	●	●
ConSite OIL (sensor)*	○	○
Dry-type air filter with evacuator valve (with air filter restriction indicator)	●	●
Electric fuel refilling pump	●	●
Engine oil drain coupler	●	●
Fan guard	●	●
Fuel cooler	●	●
Fuel pre-filter with water separator	●	●
Pre-cleaner	○	○
PWR / ECO mode control	●	●
Radiator reserve tank	●	●
Radiator, oil cooler with one touch type dust-proof indoor net	●	●
Radiator, oil cooler with one touch type cleaning interval extension net	○	○

HYDRAULIC SYSTEM	ZX75US-7	ZX85USB-7
Auxiliary flow adjustment switching	○	○
Boom anti-drift valve	●	●
ConSite OIL (sensor)*	○	○
Extra port for control valve	●	●
Full-flow filter	●	●
Hose rupture valve for arm cylinder	○	○
Hose rupture valve for boom cylinder	○	○
Hydraulic pilot type control levers	●	●
Low-temperature starting speed control	●	●
Main pump pressure and temperature sensor	●	●
Pilot control shut-off lever with neutral engine start system	●	●
Pilot filter	●	●
Suction filter	●	●
Swing auxiliary function lever (AFL)	–	●
Swing drain filter	●	●
Swing parking brake	●	●
Travel parking brake	●	●
Two-speed travel system	●	●
Valve for extra piping	●	●
Variable relief valve for breaker and crusher	●	●
Work mode selector	●	●

CAB	ZX75US-7	ZX85USB-7
AUX function lever (breaker)	●	–
AUX function lever (breaker / boom swing)	–	●
AUX function lever (breaker / boom swing assist)	○	○
Auto control air conditioner	●	●
Blade lever with two-speed travel switch	●	●
Bluetooth® integrated radio	●	●
Control lever auto-lock	●	●
Defroster	●	●
Drink holder with hot and cool function	●	●
Electric horn	●	●
Engine shut-off switch	●	●
Equipped with reinforced glass windows	●	●
Evacuation hammer	●	●
Fire extinguisher mounting seat	●	●
Footrest	●	●
Floor mat	●	●
Front window washer (1 point)**	●	●
Front window washer (2 points)**	○	○
Hands-free calling device	●	●
Hot and cool box	●	●
Intermittent windshield wipers	●	●
LED room light	●	●
Lower front window one-touch lock (release lever)	●	●
Magazine rack	○	○
OPG top guard, Level II (ISO 10262: 1998) compliant	○	○
OPG front guard, Level II (ISO 10262: 1998) compliant	○	○
Pilot shut-off lever	●	●
Power outlet 12 V	●	●
Rain guard (without OPG front guard)***	○	○
Rear tray	●	●
Retractable seat belt 3 in. (76 mm)	●	●
Rubber radio antenna	●	●
ROPS (ISO 12117-2: 2008) compliant cab	●	●
Seat: air suspension seat with heater	●	●
Seat adjustment part: backrest, armrest, height and angle, slide forward / back	●	●
Seat belt reminder	●	●
Smartphone holder	●	●
Sunscreen roller type (top window)	●	●
Sunscreen roller type (front window)	○	○
Tinted window glass (right side)	○	○
Transparent roof	●	●
USB power supply	●	●
Wide view wiper	○	○
Windows on front, upper and lower can be opened	●	●
Window (right side) guard pipe	●	–
4 fluid-filled elastic mounts	●	●
8 inch monitor	●	●
2 speakers	●	●

●: Standard equipment ○: Optional equipment -: Not applicable

MONITOR SYSTEM	ZX75US-7	ZX85USB-7
Alarms: overheat, engine warning, engine oil pressure, alternator, minimum fuel level, hydraulic filter restriction, air filter restriction, work mode, overload, etc	●	●
Alarm buzzers: overheat, engine oil pressure, overload, etc	●	●
Display of meters: water temperature, hour, fuel rate, clock, etc	●	●
Other displays: work mode, auto-idle, glow, rearview monitor, operating conditions, etc	●	●
35 language selection	●	●

FRONT ATTACHMENTS	ZX75US-7	ZX85USB-7
Arm 5' 4" (1.62 m)	○	○
Arm 6' 11" (2.12 m)	●	●
Assist (2nd Auxiliary) piping	○	○
Dirt seal on all bucket pins	●	●
Extra piping	●	●
HN bushing	●	●
HRV cover	○	○
Reinforced resin thrust plate	●	●
WC (tungsten-carbide) thermal spraying	●	●
2-piece boom	-	○
Quick coupler piping	○	○

LIGHTS	ZX75US-7	ZX85USB-7
Additional 3 cab roof front LED lights	○	○
LED working lights (boom x 1, cab front x 1)	●	●
3 ambient LED lights (side and rear view camera)	○	○

MISCELLANEOUS	ZX75US-7	ZX85USB-7
ConSite	○	○
Global e-service	●	●
Standard tool kit	●	●

UPPER STRUCTURE	ZX75US-7	ZX85USB-7
AERIAL ANGLE (270-degree view camera system)	●	●
Auxiliary overload relief valve	●	●
Batteries 2 x 60 Ah	●	●
Fuel level float	●	●
Remote swing circle lubrication	●	●
Lockable tool box	●	●
Side view mirror (left side)	●	●
Undercover	●	●
2,568 lb (1,165 kg) counterweight	●	●
948 lb (430 kg) additional counterweight	○	○
2 way battery disconnect switch	●	●

UNDERCARRIAGE	ZX75US-7	ZX85USB-7
Angle blade	○	○
Blade	●	●
Blade float	●	●
Reinforced track links with pin seals	●	●
Travel motor covers	●	●
4 tie down hooks	●	●
18" (450 mm) grouser shoe	●	●
18" (450 mm) pad crawler shoe	○	○
18" (450 mm) rubber shoe	○	○
24" (600 mm) grouser shoe	○	○

Standard and optional equipment may vary by country, so please consult your Hitachi Construction Machinery Americas authorized local dealer for details.

* Engine oil and hydraulic oil monitoring sensor.

** Front window washer (1 point) is only when equipped with standard wiper. Front window washer (2 points) is only when equipped with wide view wiper.

*** Rain guard cannot be install when Cab front top guard and cab ceiling tower guard ISO (OPG) Level II conformance (ISO 10262: 1998) are installed.



HITACHI

Reliable Solutions



REPUTATIONS ARE
BUILT ON IT.

Hitachi Construction Machinery Americas Inc. is a leading provider of construction and mining machinery services and solutions in North and Latin America. Our manufacturing facilities are located in Banshu, Ryugasaki, Tierra, Hitachinaka, and Tsuchiura, Japan, while our U.S. corporate office is in Newnan, Georgia. Our experienced team of professionals is well-equipped to design, engineer, manufacture, and service your machinery.

Through our long-term commitment to maintaining a leadership position in technology, service, and support, we support an extensive network of independent, local dealers focused on providing you with knowledgeable and experienced sales, service, and parts personnel — all backed by our dedicated support teams.

Your Hitachi Construction Machinery Americas authorized local dealer has the resources, expertise, and personnel to work with you to ensure that you receive the most benefit from your investment. You can also utilize carefully designed programs and services in conjunction with extensive digital resources. Our focus is entirely on supporting you, your business, and your machinery.

If you are searching for a reliable partner for your construction machinery needs, we invite you to explore our offerings and experience the difference with Hitachi Construction Machinery Americas.

Machines representative of global product. Options may not be available in all markets. Prior to operating this machine, including satellite communication system, in a country other than a country of its intended use, it may be necessary to make modifications to it so that it complies with the local regulatory standards (including safety standards) and legal requirements of that particular country. Please do not export or operate this machine outside the country of its intended use until such compliance has been confirmed. Please contact your Hitachi Construction Machinery Americas authorized local dealer in case of questions about compliance. These specifications are subject to change without notice. Illustrations and photos show the standard models, and may or may not include optional equipment, accessories, and all standard equipment with some differences in color and features. Before use, read and understand the Operator's Manual for proper operation.