

Product Information: Crawler Excavator

R 956

Litronic®

Generation

6

Engine

335 HP / 250 kW

Tier 4 Final

Operating Weight

59,400 kg / 130,960 lb

Bucket Capacity

1.65 – 3.50 m³

2.16 – 4.58 yd³



LIEBHERR

Experience the Progress

R 956

Safety

- Panoramic visibility with no obstructions, rear and side view monitoring cameras
- Retractable console for easy and safe access to the cab
- Emergency exit via the rear cab window, whatever the excavator's configuration
- Windshield and right-hand window in laminated tinted glass

Equipment

- Large choice of sticks
- Longer lifespan of components and higher productivity thanks to the automatic centralised lubrication system (option)
- Safety check valves for hoist and stick cylinders

Maintenance

- Maintenance points on the cool side of the engine
- Quick and easy cleaning and visual inspection
- Complementary radiators fitted on hinges
- Engine oil, hydraulic oil, fuel and urea levels visible on the display
- Shut-off valve to quickly and easily interrupt the circulation of oil between the tank and the hydraulic system





Comfort

- Spacious, air-conditioned work space
- Airsprung seat with vertical and longitudinal damping as standard
- Userfriendly high resolution 7" colour touchscreen
- 3" orange belt
- New LED lighting as standard

Engine

- New, more powerful engine that conforms with the US EPA Tier 4 Final exhaust emissions standard
- Automatic engine idling / speed increase, controlled via joystick sensors

Undercarriage

- Robust, reliable X-frame undercarriage, easy to secure thanks to its integrated eyelets
- Easy maintenance
- Maintenance-free crawler track and track rollers with lifetime lubrication
- 3-part chain guide

Technical Data



Engine

Rating	per SAE J1349 335 HP (250 kW) at 1,800 rpm per ISO 9249 340 HP (250 kW) at 1,800 rpm
Torque	2,280 Nm at 1,000 rpm / 1,682 lbf ft at 1,000 rpm
Model	Liebherr D936 A7
Type	6 cylinder in-line
Bore	130 mm / 5.1 in
Stroke	150 mm / 5.9 in
Displacement	10.5 l / 641 in³
Engine operation	4-stroke diesel Common-Rail, monoturbo
Exhaust gas treatment	Tier 4 Final SCR Filter Passive regeneration by thermo management
Cooling system	Water-cooled and integrated motor oil cooler, after-cooled and fuel cooled
Air cleaner	Dry-type air cleaner with pre-cleaner, primary and safety elements
Fuel tank	734 l / 194 gal
Urea tank	90 l / 24 gal
Electrical system	
Voltage	24 V
Batteries	2 x 180 Ah/12 V
Starter	24 V/7.8 kW
Alternator	Three-phase current 28 V/140 A
Engine idling	Sensor controlled
Motor management	Connection to the integrated excavator system controlling via CAN-BUS to the economical utilisation of the service that is available



Hydraulic Controls

The controlling is conducted via the integrated excavator system technology, input and output modules, communicated via the CAN-BUS with the electronic central unit

Power distribution	Via control valves in single block with integrated safety valves
Flow summation	To boom and stick
Closed-loop circuit	For uppercarriage swing drive
Servo circuit	
Equipment and swing	Proportional via joystick levers
Travel	- Proportional control via foot pedals or removable levers - Speed pre-selection
Additional functions	Proportional regulation via foot pedals or mini-joystick



Hydraulic System

Hydraulic pumps	
For equipment and travel drive	Liebherr, variable displacement, swashplate double pump
Max. flow	2 x 380 l/min. / 2 x 100 gpm
Max. pressure	350 bar / 5,076 psi
For swing drive	Reversible, variable displacement, swashplate pump, closed-loop circuit
Max. flow	201 l/min. / 53 gpm
Max. pressure	375 bar / 5,439 psi
Pump regulation	Electro-hydraulic with electronic engine speed sensing regulation, pressure compensation, flow compensation
Hydraulic tank	380 l / 100 gal
Hydraulic system	743 l / 196 gal
Hydraulic oil filter	2 full flow filters in return line with integrated fine filter area (5 µm / 2,500 mesh)
Cooling system	Compact cooler for water cooler, after-cooler, fuel cooler and transmission pump oil, sandwiched with cooler for oil and condenser of air-conditioning with hydrostatically controlled fan drives
MODE selection	Adjustment of engine and hydraulic performance via a mode pre-selector to match application, e.g. for especially economical and environmentally friendly operation or for maximum digging performance and heavy-duty jobs
RPM adjustment	Stepless adjustment of engine output via RPM at each selected mode
Tool Control	20 preadjustable pump flows and pressures for add-on attachments



Swing Drive

Drive	Liebherr swashplate motor with integrated brake valve
Transmission	Liebherr compact planetary reduction gears
Swing ring	Liebherr, sealed race ball bearing swing ring, internal teeth
Swing speed	0 – 5.8 rpm stepless
Swing torque	160 kNm / 118,010 lbf ft
Holding brake	Wet multi-disc (spring applied, pressure released)



Operator's Cab

Cab	LED work headlights integrated in the ceiling, a door with a sliding window (can be opened on both sides), large storing box and several stowing possibilities, shock-absorbing suspension, sounddamping insulating, tinted laminated safety glass, separate window shades for the sunroof window and windscreen, cigarette lighter and 12 V plug, storage bins, lunchbox, cup holder
Operator's seat	Liebherr-Comfort seat, airsprung with automatic weight adjustment, vertical and longitudinal seat damping including consoles and joysticks. Seat and armrests adjustable separately and in combination (adjustable in width, height and inclination), seat heating as standard
Arm consoles	Oscillating consoles with seat, tiltable console left
Operation and displays	Large high-resolution operating unit, intuitive, color display with touchscreen, video-compatible, numerous setting, control and monitoring options, e.g. air conditioning control, fuel consumption, machine and attachment parameters
Air-conditioning	Automatic air-conditioning, recirculated air function, fast de-icing and demisting at the press of a button, air vents can be operated via a menu. Recirculated air and fresh air filters can be easily replaced and are accessible from the outside. Heating-cooling unit, designed for extreme outside temperatures, sensors for solar radiation, inside and outside temperatures
Noise emission	
ISO 6396	L_{pA} (inside cab) = 72 dB(A)
2000/14/EC	L_{WA} (surround noise) = 106 dB(A)



Undercarriage

Versions	
LC-V	Gauge 2,890 mm / 9'6"
HD	Gauge 2,900 mm / 9'6"
Drive	Liebherr swashplate motor with integrated brake valve
Transmission	Liebherr compact planetary reduction gear
Maximum travel speed	Low range 2.6 km/h / 1.6 mph High range 3.7 km/h / 2.3 mph
Drawbar pull on crawler	446 kN / 100,265 lbf
Track components	D8L, maintenance-free
Track rollers/Carrier rollers	LC-V: 10/3 HD: 9/2
Tracks	Sealed and greased
Track pads	Triple grouser
Holding brake	Wet multi-disc (spring applied, pressure released)
Brake valves	Integrated into travel motor
Lashing eyes	Integrated



Equipment

Type	Combination of resistant steel plates and cast steel components
Hydraulic cylinders	Liebherr cylinders with seal and guidance systems
Bearings	Sealed, low maintenance
Lubrication	Automatic central lubrication system (except link and tilt geometry)
Hydraulic connections	Pipes and hoses equipped with SAE split-flange connections
Buckets	Standard equipped with Liebherr tooth system

Dimensions

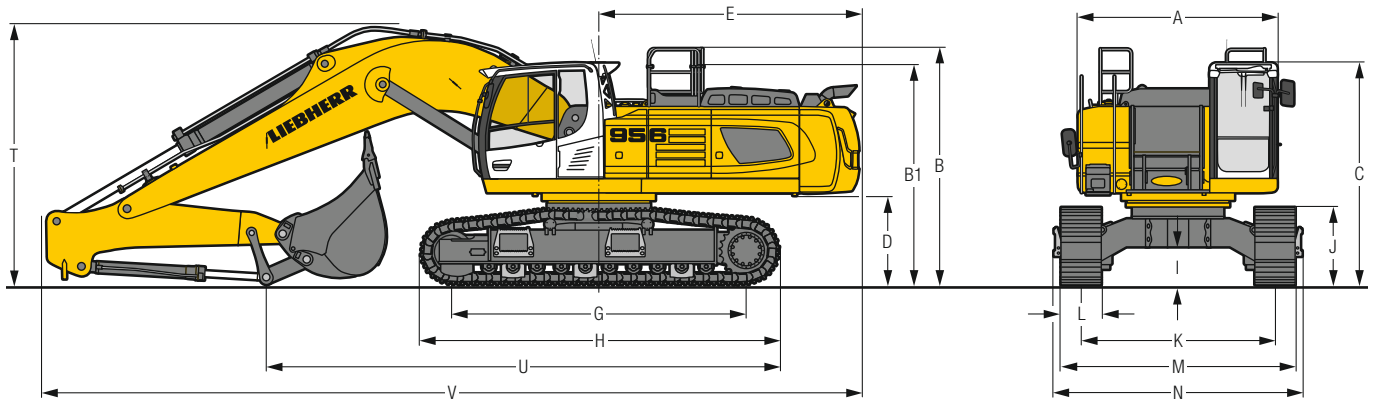

	HD	mm/ft in			LC-V	mm/ft in		
A*	Upper-carriage width	2,970/ 9' 9"				2,970/ 9' 9"		
B	Upper-carriage height	3,555/11' 8"				3,660/12'		
B1	Upper-carriage height (handrails folded)	3,305/10'10"				3,410/11' 2"		
C	Cab height	3,335/3,530***/10'11"/11' 7"***				3,440/3,635***/11'3"/11'11"***		
D	Counterweight ground clearance	1,355/ 4' 5"				1,460/ 4' 9"		
E	Rear-end length	3,900/12'10"				3,900/12'10"		
G	Wheelbase	4,500/14' 9"				4,500/14' 9"		
H	Undercarriage length	5,550/18' 3"				5,550/18' 3"		
I	Undercarriage ground clearance	575/ 1'11"				800/ 2' 7"		
J	Track height	1,225/ 4'				1,210/ 4'		
K	Track gauge	2,900/ 9' 6"				2,390/2,890**/ 7'10"/ 9' 6"***		
L	Track pad width	500/ 20"	600/ 24"	750/ 30"		500 / 20"	600 / 24"	750 / 30"
M	Width over tracks	3,465/11' 4"	3,500/11' 6"	3,650/12'		2,970/3,470**/ 9'9"/11' 5"***	2,990/3,490**/ 9'10"/11' 5"***	3,140/3,640**/10' 4"/11'11"***
N	Width over steps	3,715/12' 2"	3,715/12' 2"	3,715/12' 2"		3,225/3,725**/10'7"/12' 3"***	3,225/3,725**/10' 7"/12' 3"***	3,225/3,725**/10' 7"/12' 3"***

* without door stop device and spacer

** work position

*** with FOPS top guard

	Stick length m/ft in	Mono boom 6.70 m/22'		Mono boom 7.60 m/24'11"		Mono boom straight 8.00 m/26'3"		Mono boom 9.20 m/30'2"	
		direct mounting mm/ft in		direct mounting mm/ft in		direct mounting mm/ft in		direct mounting mm/ft in	
		HD	LC-V	HD	LC-V	HD		LC-V	
T	Boom height	2.35/ 7'9"	3,900 /12'10"	4,000 /13'1"	3,900/12'10"	4,000/13'1"	3,600/11'10"		
		2.90/ 9'6"	3,950 /13'	4,050 /13'3"	3,950/13'	4,050/13'3"	3,700/12' 2"		4,250/13'11"
		3.80/12'6"	3,900*/12'10"*	4,000*/13'1"*	4,000/13' 1"	4,100/13'5"	3,850/12' 8"		4,350/14' 3"
		5.00/16'5"	—	—	—	—	—		4,450/14' 7"
U	Length on ground	2.35/ 7'9"	7,750 /25' 5"		7,700/25'3"		8,350/27' 5"		—
		2.90/ 9'6"	7,200 /23' 7"		8,300/37'3"		7,900/25'11"		8,900/29' 2"
		3.80/12'6"	9,400*/30'10"*		7,400/24'3"		8,250/27' 1"		9,150/30'
		5.00/16'5"	—		—		—		7,900/25'11"
V	Overall length	2.35/ 7'9"	12,200 /40'		13,250/43'6"		13,800/45' 3"		14,850/48' 9"
		2.90/ 9'6"	12,250 /40' 2"		13,250/43'6"		13,700/44'11"		14,850/48' 9"
		3.80/12'6"	12,200*/40'*		13,250/43'6"		13,700/44'11"		14,850/48' 9"
		5.00/16'5"	—		—		—		—
	Bucket	2.70 m³/3.53 yd³		2.00 m³/2.62 yd³		2.00 m³/2.62 yd³		1.65 m³/2.16 yd³	

* without bucket

Transport Dimensions removable elements disassembled

	Undercarriage/ Stick m/ft in	Mono boom 6.70 m/22'			Mono boom 7.60 m/24'11"			Mono boom straight 8.00 m/26'3"			Mono boom 9.20 m/30'2"		
		mm/ft in			mm/ft in			mm/ft in			mm/ft in		
		HD	LC-V	HD	LC-V	HD	LC-V	HD	LC-V	HD	LC-V		
Pad width		500/ 20"	600/ 24"	750/ 30"	500/ 20"	600/ 24"	750/ 30"	500/ 20"	600/ 24"	750/ 30"	500/ 20"	600/ 24"	750/ 30"
Transport width	HD	3,715/12' 2"	3,715/12' 2"	3,715/12' 2"	3,715/12' 2"	3,715/12' 2"	3,715/12' 2"	3,715/12' 2"	3,715/12' 2"	3,715/12' 2"			
	LC-V	3,225/10' 7"	3,225/10' 7"	3,225/10' 7"	3,225/10' 7"	3,225/10' 7"	3,225/10' 7"	3,225/10' 7"	3,225/10' 7"	—		3,225/10' 7"	3,225/10' 7"
Transport length	2.35/ 7'9"		12,200/40'		13,250/43'6"		13,800/45' 3"		—		—		—
	2.90/ 9'6"		12,250/40'2"		13,250/43'6"		13,700/44'11"		—		—	14,850/48'9"	—
	3.80/12'6"		12,200*/40'*		13,250/43'6"		13,700/44'11"		—		—	14,850/48'9"	—
	5.00/16'5"		—		—		—		—		—	14,850/48'9"	—
Transport height	2.35/ 7'9"	3,900/12'10"	4,000/13'1"	3,900/12'10"	4,000/13'1"	3,600/11'10"							
	2.90/ 9'6"	3,950/13'	4,050/13'3"	3,950/13'	4,050/13'3"	3,700/12' 2"						4,250/13'11"	
	3.80/12'6"	3,900/12'10"	4,000/13'1"	4,000/13' 1"	4,100/13'5"	3,850/12' 8"						4,350/14' 3"	
	5.00/16'5"	—	—	—	—	—						4,450/14' 7"	
	Bucket	2.70 m³/3.53 yd³			2.00 m³/2.62 yd³			2.00 m³/2.62 yd³			1.65 m³/2.16 yd³		

* without bucket

Backhoe Bucket

with Mono Boom 6.70 m/22' and Counterweight 11.0 t/24,250 lb

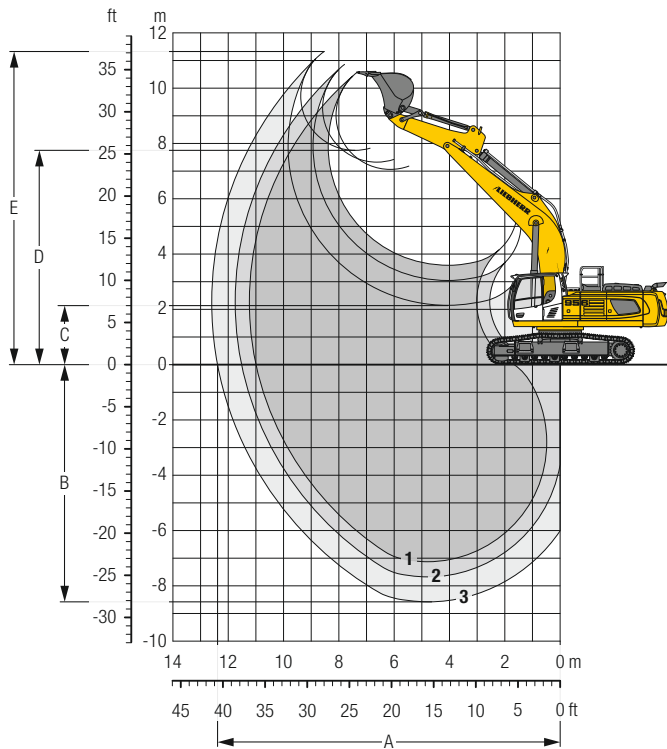

Digging Envelope

without quick coupler	1	2	3
Stick length	m/ft in 2.35/ 7' 9"	2.90/ 9' 6"	3.80/12'6"
A Max. reach at ground level	m/ft in 11.10/36' 5"	11.50/37' 9"	12.40/40'8"
B Max. digging depth	m/ft in 7.15/23' 5"	7.70/25' 3"	8.60/28'3"
C Min. dumping height	m/ft in 3.60/11'10"	3.05/10'	3.15/10'4"
D Max. dumping height	m/ft in 7.05/23' 2"	7.30/23'11"	7.70/25'3"
E Max. cutting height	m/ft in 10.55/34' 7"	10.85/35' 7"	11.30/37'1"

Forces

without quick coupler	1	2	3
Stick digging force (ISO 6015)	kN/lbf 249/55,980	218/49,010	182/40,920
Bucket digging force (ISO 6015)	kN/lbf 316/71,040	316/71,040	316/71,040
Stick digging force (SAE J1179)	kN/lbf 235/52,830	207/46,540	174/39,120
Bucket digging force (SAE J1179)	kN/lbf 273/61,370	273/61,370	273/61,370

Max. bucket digging force ISO with ripper bucket

345 kN/77,560 lbf

Operating Weight and Ground Pressure

The operating weight includes the basic machine with counterweight 11.0 t/24,250 lb, mono boom 6.70 m/22', stick 2.90 m/9'6" and HD bucket 2.70 m³/3.53 yd³ (3,100 kg/6,830 lb).

Undercarriage	HD		
Pad width	mm/in 500/20"	600/24"	750/30"
Weight	kg/lb 55,500/122,360	56,050/123,570	56,850/125,330
Ground pressure	kg/cm ² /psi 1.14/16.2	0.96/13.7	0.78/11.1

Undercarriage	LC-V		
Pad width	mm/in 500/20"	600/24"	750/30"
Weight	kg/lb 58,050/127,980	58,600/129,190	59,400/130,960
Ground pressure	kg/cm ² /psi 1.19/16.9	1.00/14.2	0.82/11.7

Optional: removable counterweight 12.0 t/26,460 lb

(removable counterweight 12.0 t/26,460 lb increases the operating weight by 1,000 kg/2,210 lb and ground pressure by 0.02 kg/cm²/0.3 psi) see load tables on page 18 and 19

Buckets Machine stability per ISO 10567* (75% of tipping capacity)

	Cutting width mm in	Capacity ISO 7451 m ³ yd ³	Weight kg lb	HD-Undercarriage (with track pads 600 mm/24")			LC-V-Undercarriage (with track pads 600 mm/24")		
				Stick length (m/ft in)			Stick length (m/ft in)		
				2.35 7'9"	2.90 9'6"	3.80 12'6"	2.35 7'9"	2.90 9'6"	3.80 12'6"
with counterweight 11.0 t/24,250 lb									
STD ¹⁾	1,550 61"	2.00 2.62	2,250 4,960	▲	▲	▲	▲	▲	▲
	1,750 69"	2.35 3.07	2,450 5,400	▲	▲	▲	▲	▲	▲
	1,950 77"	2.70 3.53	2,650 5,840	▲	▲	△	▲	▲	△
	1,950 77"	3.00 3.92	2,750 6,060	▲	▲	△	▲	▲	△
	2,100 83"	3.30 4.32	2,850 6,280	▲	■	-	▲	▲	-
	1,550 61"	2.00 2.62	2,650 5,840	▲	▲	▲	▲	▲	▲
HD ²⁾	1,750 69"	2.35 3.07	2,850 6,280	▲	▲	■	▲	▲	■
	1,950 77"	2.70 3.53	3,100 6,830	▲	▲	△	▲	▲	△
	1,950 77"	3.00 3.92	3,200 7,060	▲	▲	-	▲	▲	-
	1,950 77"	3.30 4.32	3,250 7,170	▲	■	-	▲	▲	-
	2,100 83"	3.50 4.58	3,500 7,720	■	▲	-	▲	■	-
	with counterweight 12.0 t/26,460 lb								
STD ¹⁾	1,550 61"	2.00 2.62	2,250 4,960	▲	▲	▲	▲	▲	▲
	1,750 69"	2.35 3.07	2,450 5,400	▲	▲	▲	▲	▲	▲
	1,950 77"	2.70 3.53	2,650 5,840	▲	▲	△	▲	▲	△
	1,950 77"	3.00 3.92	2,750 6,060	▲	▲	△	▲	▲	△
	2,100 83"	3.30 4.32	2,850 6,280	▲	▲	-	▲	▲	-
	1,550 61"	2.00 2.62	2,650 5,840	▲	▲	▲	▲	▲	▲
HD ²⁾	1,750 69"	2.35 3.07	2,850 6,280	▲	▲	■	▲	▲	■
	1,950 77"	2.70 3.53	3,100 6,830	▲	▲	△	▲	▲	△
	1,950 77"	3.00 3.92	3,200 7,060	▲	▲	-	▲	▲	-
	1,950 77"	3.30 4.32	3,250 7,170	▲	▲	-	▲	▲	-
	2,100 83"	3.50 4.58	3,500 7,720	▲	■	-	▲	■	-

* Indicated loads are based on ISO 10567, at maximum reach, and may be swung 360° on firm and even ground

¹⁾ Standard bucket with Liebherr teeth Z 70 (appropriate for materials up to classification 5, according to VOB, Section C, DIN 18300)

²⁾ HD bucket with Liebherr teeth Z 70 (appropriate for materials above classification 6, according to VOB, Section C, DIN 18300)

Other buckets available upon request

Max. material weight ▲ = ≤ 2.0 t/m³/3,400 lb/yd³, ■ = ≤ 1.8 t/m³/3,000 lb/yd³, ▲ = ≤ 1.65 t/m³/2,800 lb/yd³, ■ = ≤ 1.5 t/m³/2,500 lb/yd³, △ = ≤ 1.2 t/m³/2,000 lb/yd³, - = not authorized

Backhoe Bucket

with Mono Boom 7.60 m/24'11" and Counterweight 11.0 t/24,250 lb

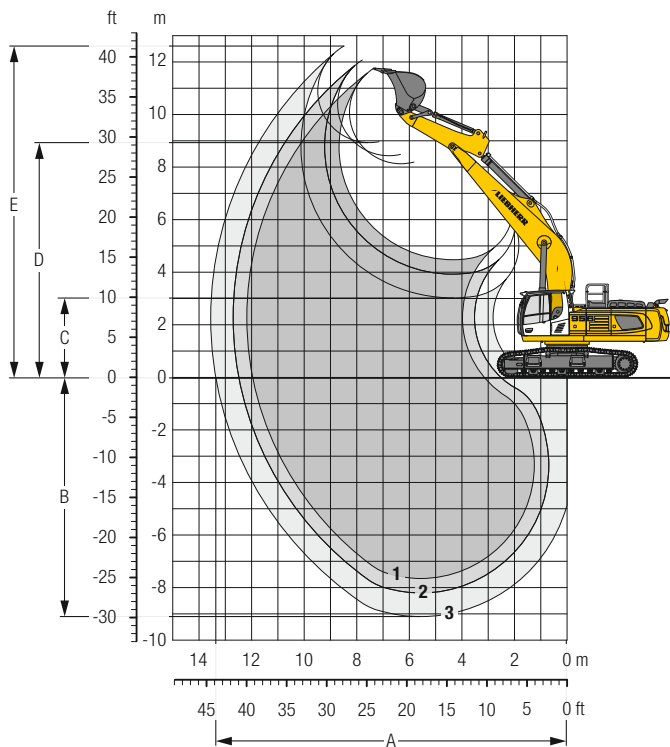

Digging Envelope

without quick coupler		1	2	3
Stick length	m/ft in	2.35/ 7'9"	2.90/ 9' 6"	3.80/ 12' 6"
A Max. reach at ground level	m/ft in	11.95/ 39'2"	12.50/ 41'	13.35/ 43'10"
B Max. digging depth	m/ft in	7.65/ 25'1"	8.20/ 26'11"	9.10/ 29'10"
C Min. dumping height	m/ft in	4.45/ 14'6"	3.90/ 12'10"	3.00/ 9'10"
D Max. dumping height	m/ft in	8.10/ 26'7"	8.40/ 27' 7"	8.90/ 29' 2"
E Max. cutting height	m/ft in	11.70/ 38'5"	12.05/ 39' 6"	12.60/ 41' 4"

Forces

without quick coupler		1	2	3
Stick digging force (ISO 6015)	kN/lbf	249/ 55,980	218/ 49,010	182/ 40,920
Bucket digging force (ISO 6015)	kN/lbf	316/ 71,040	316/ 71,040	316/ 71,040
Stick digging force (SAE J1179)	kN/lbf	235/ 52,830	207/ 46,540	174/ 39,120
Bucket digging force (SAE J1179)	kN/lbf	273/ 61,370	273/ 61,370	273/ 61,370

Max. bucket digging force ISO with ripper bucket

345 kN/ 77,560 lbf

Operating Weight and Ground Pressure

The operating weight includes the basic machine with counterweight 11.0 t/ 24,250 lb, mono boom 7.60 m/ 24'11", stick 2.90 m/ 9'6" and bucket 2.00 m³/ 2.62 yd³ (2,250 kg/ 4,960 lb).

Undercarriage		HD		
Pad width	mm/in	500/ 20"	600/ 24"	750/ 30"
Weight	kg/lb	55,100/ 121,480	55,650/ 122,690	56,450/ 124,450
Ground pressure	kg/cm ² / psi	1.13/ 16.1	0.95/ 13.5	0.77/ 11.0

Undercarriage		LC-V		
Pad width	mm/in	500/ 20"	600/ 24"	750/ 30"
Weight	kg/lb	57,650/ 127,100	58,200/ 128,310	59,000/ 130,070
Ground pressure	kg/cm ² / psi	1.18/ 16.8	0.99/ 14.1	0.81/ 11.5

Optional: removable counterweight 12.0 t/ 26,460 lb

(removable counterweight 12.0 t/ 26,460 lb increases the operating weight by 1,000 kg/ 2,210 lb and ground pressure by 0.02 kg/cm²/ 0.3 psi) see load tables on page 22 and 23

Buckets Machine stability per ISO 10567* (75% of tipping capacity)

	Cutting width mm in	Capacity ISO 7451 m ³ yd ³	Weight kg lb	HD-Undercarriage (with track pads 600 mm/24")			LC-V-Undercarriage (with track pads 600 mm/24")		
				Stick length (m/ft in)			Stick length (m/ft in)		
				2.35 7'9"	2.90 9'6"	3.80 12'6"	2.35 7'9"	2.90 9'6"	3.80 12'6"
with counterweight 11.0 t/24,250 lb									
STD ¹⁾	1,550 61"	2.00 2.62	2,250 4,960	▲	▲	▲	▲	▲	▲
	1,750 69"	2.35 3.07	2,450 5,400	▲	▲	▲	▲	▲	▲
	1,950 77"	2.70 3.53	2,650 5,840	▲	■	△	▲	▲	△
	1,950 77"	3.00 3.92	2,750 6,060	■	▲	△	■	▲	△
	2,100 83"	3.30 4.32	2,850 6,280	▲	△	-	▲	■	-
HD ²⁾	1,550 61"	2.00 2.62	2,650 5,840	▲	▲	■	▲	▲	■
	1,750 69"	2.35 3.07	2,850 6,280	▲	▲	■	▲	▲	■
	1,950 77"	2.70 3.53	3,100 6,830	■	▲	△	▲	■	△
	1,950 77"	3.00 3.92	3,200 7,060	▲	■	-	■	▲	-
	with counterweight 12.0 t/26,460 lb								
STD ¹⁾	1,550 61"	2.00 2.62	2,250 4,960	▲	▲	▲	▲	▲	▲
	1,750 69"	2.35 3.07	2,450 5,400	▲	▲	▲	▲	▲	▲
	1,950 77"	2.70 3.53	2,650 5,840	▲	▲	△	▲	▲	△
	1,950 77"	3.00 3.92	2,750 6,060	▲	■	△	▲	■	△
	2,100 83"	3.30 4.32	2,850 6,280	■	■	-	■	▲	-
HD ²⁾	1,550 61"	2.00 2.62	2,650 5,840	▲	▲	■	▲	▲	■
	1,750 69"	2.35 3.07	2,850 6,280	▲	▲	■	▲	▲	■
	1,950 77"	2.70 3.53	3,100 6,830	▲	■	△	▲	▲	△
	1,950 77"	3.00 3.92	3,200 7,060	■	▲	-	▲	■	-

* Indicated loads are based on ISO 10567, at maximum reach, and may be swung 360° on firm and even ground

¹⁾ Standard bucket with Liebherr teeth Z 70 (appropriate for materials up to classification 5, according to VOB, Section C, DIN 18300)

²⁾ HD bucket with Liebherr teeth Z 70 (appropriate for materials above classification 6, according to VOB, Section C, DIN 18300)

Other buckets available upon request

Max. material weight ▲ = ≤ 2.0 t/m³/3,400 lb/yd³, ■ = ≤ 1.8 t/m³/3,000 lb/yd³, ▲ = ≤ 1.65 t/m³/2,800 lb/yd³, ■ = ≤ 1.5 t/m³/2,500 lb/yd³, △ = ≤ 1.2 t/m³/2,000 lb/yd³, - = not authorized

Backhoe Bucket

with Mono Boom Straight 8.00 m/26'3" and Counterweight 11.0 t/24,250 lb

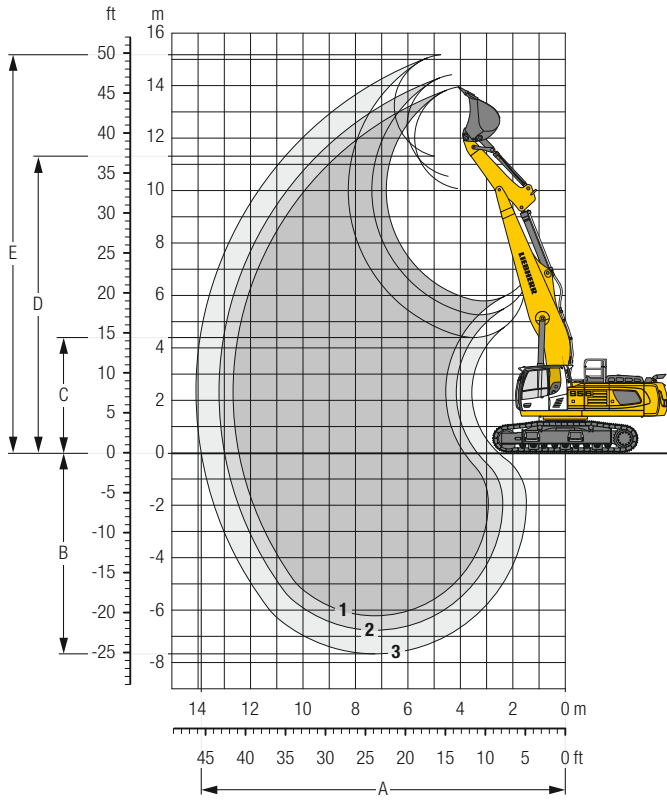

Digging Envelope

without quick coupler	1	2	3
Stick length	m/ft in 2.35/ 7' 9"	2.90/ 9' 6"	3.80/12' 6"
A Max. reach at ground level	m/ft in 12.45/40'10"	13.00/42' 8"	13.90/45' 7"
B Max. digging depth	m/ft in 6.20/20' 4"	6.75/22' 2"	7.65/25' 1"
C Min. dumping height	m/ft in 5.80/19'	5.25/17' 3"	4.40/14' 5"
D Max. dumping height	m/ft in 10.05/33'	10.55/34' 7"	12.30/40' 4"
E Max. cutting height	m/ft in 13.95/45' 9"	14.40/47' 3"	15.20/49'10"

Forces

without quick coupler	1	2	3
Stick digging force (ISO 6015)	kN/lbf 249/55,980	218/49,010	182/40,920
Bucket digging force (ISO 6015)	kN/lbf 316/71,040	316/71,040	316/71,040
Stick digging force (SAE J1179)	kN/lbf 235/52,830	207/46,540	174/39,120
Bucket digging force (SAE J1179)	kN/lbf 273/61,370	273/61,370	273/61,370

Max. bucket digging force ISO with ripper bucket 345 kN/77,560 lbf

Operating Weight and Ground Pressure

The operating weight includes the basic machine with counterweight 11.0 t/24,250 lb, mono boom straight 8.00 m/26'3", stick 2.90 m/9'6" and bucket 2.00 m³/2.62 yd³ (2,250 kg/4,960 lb).

Undercarriage	HD		
Pad width	mm/in 500/20"	600/24"	750/30"
Weight	kg/lb 55,150/121,590	55,700/122,800	56,500/124,560
Ground pressure	kg/cm ² /psi 1.13/16.1	0.95/13.5	0.77/11.0

Optional: removable counterweight 12.0 t/26,460 lb (removable counterweight 12.0 t/26,460 lb increases the operating weight by 1,000 kg/2,210 lb and ground pressure by 0.02 kg/cm²/0.3 psi) see load tables on page 25

Buckets Machine stability per ISO 10567* (75% of tipping capacity)

	Cutting width	Capacity ISO 7451	Weight	HD-Undercarriage (with track pads 600 mm/24")			
				Stick length (m/ft in)			
				2.35 7'9"	2.90 9'6"	3.80 12'6"	
				with counterweight 11.0 t/24,250 lb			
STD ¹⁾	1,350 53"	1.65 2.16	2,100 4,630	▲	▲	▲	
	1,550 61"	2.00 2.62	2,250 4,960	▲	▲	■	
	1,750 69"	2.35 3.07	2,450 5,400	▲	■	■	
	1,950 77"	2.70 3.53	2,650 5,840	■	■	△	
	1,950 77"	3.00 3.92	2,750 6,060	■	△	-	
	HD ²⁾	1,350 53"	1.65 2.16	2,350 5,180	▲	▲	▲
1,550 61"		2.00 2.62	2,650 5,840	▲	▲	▲	
1,750 69"		2.35 3.07	2,850 6,280	▲	▲	△	
1,950 77"		2.70 3.53	3,100 6,830	▲	△	△	
with counterweight 12.0 t/26,460 lb							
STD ¹⁾		1,350 53"	1.65 2.16	2,100 4,630	▲	▲	▲
	1,550 61"	2.00 2.62	2,250 4,960	▲	▲	▲	
	1,750 69"	2.35 3.07	2,450 5,400	▲	▲	■	
	1,950 77"	2.70 3.53	2,650 5,840	▲	▲	△	
	1,950 77"	3.00 3.92	2,750 6,060	▲	■	△	
	HD ²⁾	1,350 53"	1.65 2.16	2,350 5,180	▲	▲	▲
1,550 61"		2.00 2.62	2,650 5,840	▲	▲	■	
1,750 69"		2.35 3.07	2,850 6,280	▲	■	△	
1,950 77"		2.70 3.53	3,100 6,830	■	■	△	

* Indicated loads are based on ISO 10567, at maximum reach, and may be swung 360° on firm and even ground

¹⁾ Standard bucket with Liebherr teeth Z 70 (appropriate for materials up to classification 5, according to VOB, Section C, DIN 18300)

²⁾ HD bucket with Liebherr teeth Z 70 (appropriate for materials above classification 6, according to VOB, Section C, DIN 18300)

Other buckets available upon request

Max. material weight ▲ = ≤ 2.0 t/m³/3,400 lb/yd³, ■ = ≤ 1.8 t/m³/3,000 lb/yd³, ▲ = ≤ 1.65 t/m³/2,800 lb/yd³, ■ = ≤ 1.5 t/m³/2,500 lb/yd³, △ = ≤ 1.2 t/m³/2,000 lb/yd³, - = not authorized

Backhoe Bucket

with Mono Boom 9.20 m/30'2" and Counterweight 11.0 t/24,250 lb

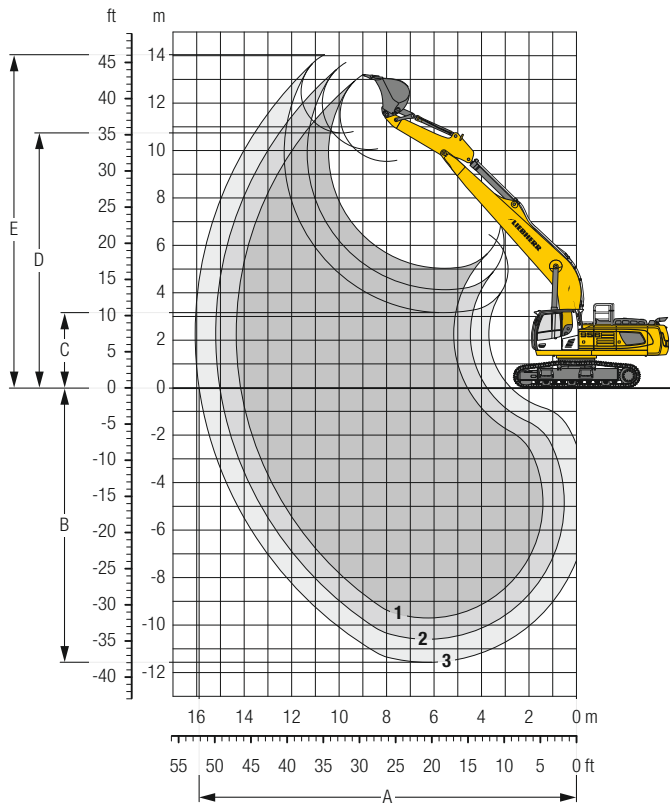

Digging Envelope

without quick coupler		1	2	3*
Stick length	m/ft in	2.90/ 9' 6"	3.80/12' 6"	5.00/16' 5"
A Max. reach at ground level	m/ft in	14.10/46' 3"	15.00/49' 3"	15.90/52' 2"
B Max. digging depth	m/ft in	9.70/31'10"	10.60/34' 9"	11.60/38' 1"
C Min. dumping height	m/ft in	5.05/16' 7"	4.15/13' 7"	3.15/10' 4"
D Max. dumping height	m/ft in	9.55/31' 4"	10.05/33'	10.75/35' 3"
E Max. cutting height	m/ft in	13.15/43' 2"	13.70/44'11"	14.00/45'11"

Forces

without quick coupler		1	2	3*
Stick digging force (ISO 6015)	kN/lbf	218/49,010	182/40,920	149/33,500
Bucket digging force (ISO 6015)	kN/lbf	316/71,040	316/71,040	235/52,830
Stick digging force (SAE J1179)	kN/lbf	207/46,540	174/39,120	145/32,600
Bucket digging force (SAE J1179)	kN/lbf	273/61,370	273/61,370	209/46,990

* with kinematic R 946 Litronic

Operating Weight and Ground Pressure

The operating weight includes the basic machine with counterweight 11.0 t/24,250 lb, mono boom 9.20 m/30'2", stick 3.80 m/12'6" and bucket 1.65 m³/2.16 yd³ (2,100 kg/4,630 lb).

Undercarriage		LC-V		
Pad width	mm/in	500/20"	600/24"	750/30"
Weight	kg/lb	57,850/127,540	58,400/128,750	59,200/130,510
Ground pressure	kg/cm ² /psi	1.19/16.9	1.00/14.2	0.81/11.5

Optional: removable counterweight 12.0 t/26,460 lb

(removable counterweight 12.0 t/26,460 lb increases the operating weight by 1,000 kg/2,210 lb and ground pressure by 0.02 kg/cm²/0.3 psi) see load tables on page 28 and 29

Buckets Machine stability per ISO 10567* (75% of tipping capacity)

	Cutting width	Capacity ISO 7451	Weight	LC-V-Undercarriage (with track pads 600 mm/24")		
				Stick length (m/ft in)		
				2.90 9'6"	3.80 12'6"	5.00 16'5"
with counterweight 11.0 t/24,250 lb						
STD ¹⁾	1,350 53"	1.65 2.16	2,100 4,630	▲	▲	-
	1,550 61"	2.00 2.62	2,250 4,960	■	■	-
	1,750 69"	2.35 3.07	2,450 5,400	■	△	-
STD ²⁾	1,200 47"	1.25 1.63	1,300 2,870	-	-	▲
	1,350 53"	1.50 1.96	1,400 3,090	-	-	▲
	1,500 59"	1.75 2.29	1,500 3,310	-	-	■
	1,650 65"	2.00 2.62	1,600 3,530	-	-	■
with counterweight 12.0 t/26,460 lb						
STD ¹⁾	1,350 53"	1.65 2.16	2,100 4,630	▲	▲	-
	1,550 61"	2.00 2.62	2,250 4,960	▲	▲	-
	1,750 69"	2.35 3.07	2,450 5,400	▲	△	-
STD ²⁾	1,950 77"	2.70 3.53	2,650 5,840	△	△	-
	1,950 77"	3.00 3.92	2,750 6,060	△	-	-
	1,200 47"	1.25 1.63	1,300 2,870	-	-	▲
	1,350 53"	1.50 1.96	1,400 3,090	-	-	▲
	1,500 59"	1.75 2.29	1,500 3,310	-	-	■
	1,650 65"	2.00 2.62	1,600 3,530	-	-	■

* Indicated loads are based on ISO 10567, at maximum reach, and may be swung 360° on firm and even ground

¹⁾ Standard bucket with Liebherr teeth Z 70 (appropriate for materials up to classification 5, according to VOB, Section C, DIN 18300)

²⁾ Standard bucket from R 946 **Litronic** with Liebherr teeth Z 50 (appropriate for materials up to classification 5, according to VOB, Section C, DIN 18300)

Other buckets available upon request

Max. material weight ▲ = ≤ 2.0 t/m³/3,400 lb/yd³, ■ = ≤ 1.8 t/m³/3,000 lb/yd³, ▲ = ≤ 1.65 t/m³/2,800 lb/yd³, ■ = ≤ 1.5 t/m³/2,500 lb/yd³, △ = ≤ 1.2 t/m³/2,000 lb/yd³, - = not authorized

Lift Capacities

with Mono Boom 6.70 m/22', Counterweight 11.0 t/24,250 lb and Track Pads 750 mm/30"

Stick 2.35 m / 7'9"

Under-carriage	Height	3.0 m 10 ft		4.5 m 15 ft		6.0 m 20 ft		7.5 m 25 ft		9.0 m 30 ft		10.5 m 35 ft		m ft in	
		Can be slewed through 360°	In longitudinal position of undercarriage	Can be slewed through 360°	In longitudinal position of undercarriage	Can be slewed through 360°	In longitudinal position of undercarriage	Can be slewed through 360°	In longitudinal position of undercarriage	Can be slewed through 360°	In longitudinal position of undercarriage	Can be slewed through 360°	In longitudinal position of undercarriage		
LC-V	9.0 m t												10.2*	10.2*	6.2
	30 ft lb														
	7.5 m t							11.5*	11.5*				9.2*	9.2*	7.6
	25 ft lb												20.4*	20.4*	24.6"
	6.0 m t					13.2*	13.2*	11.7*	11.7*				8.9*	8.9*	8.4
	20 ft lb					28.4*	28.4*	25.6*	25.6*				19.6*	19.6*	27.7"
	4.5 m t			21.8*	21.8*	15.2*	15.2*	12.6*	12.6*	9.3*	9.3*		8.9*	8.9*	9.0
	15 ft lb			45.9*	45.9*	32.7*	32.7*	27.4*	27.4*				19.5*	19.5*	29.5"
	3.0 m t					17.0*	17.3*	12.6*	13.7*	9.8*	11.8*		9.2*	9.2*	9.2
	10 ft lb					36.7*	37.3*	27.1*	29.6*	20.9*	25.7*		20.2*	20.2*	30.4"
1.5 m t					16.4*	18.7*	12.2*	14.5*	9.5*	12.2*		9.2*	9.8*	9.2	
5 ft lb					35.2*	40.2*	26.2*	31.4*	20.5*	26.3*		20.3*	21.6*	30.4"	
0 m t			15.8*	15.8*	16.1*	19.0*	11.9*	14.8*				9.5*	10.9*	9.0	
0 ft lb			37.5*	37.5*	34.6*	40.9*	25.7*	32.0*				21.0*	24.1*	29.5"	
-1.5 m t	15.4*	15.4*	23.6*	23.6*	16.1*	18.3*	11.9*	14.4*				10.4*	12.4*	8.4	
-5 ft lb	35.4*	35.4*	51.2*	51.2*	34.6*	39.5*	25.7*	31.0*				23.0*	27.3*	27.7"	
-3.0 m t	26.0*	26.0*	21.0*	21.0*	16.4*	16.4*						12.4*	12.5*	7.5	
-10 ft lb	56.6*	56.6*	45.3*	45.3*	35.2*	35.3*						27.4*	27.4*	24.7"	
-4.5 m t			16.1*	16.1*								11.8*	11.8*	6.1	
-15 ft lb			34.3*	34.3*								25.8*	25.8*	19.8"	
-6.0 m t															
-20 ft lb															
HD	9.0 m t												10.3*	10.3*	6.2
	30 ft lb														
	7.5 m t							10.5*	10.5*				9.3*	9.3*	7.6
	25 ft lb												20.5*	20.5*	24.6"
	6.0 m t					13.1*	13.1*	11.7*	11.7*				8.9*	8.9*	8.4
	20 ft lb					28.2*	28.2*	25.5*	25.5*				19.6*	19.6*	27.7"
	4.5 m t			21.3*	21.3*	15.1*	15.1*	12.6*	12.6*				8.9*	8.9*	9.0
	15 ft lb			45.1*	45.1*	32.4*	32.4*	27.2*	27.2*				19.5*	19.5*	29.5"
	3.0 m t			16.4*	17.2*	12.1*	13.6*			9.4*	11.8*		9.0*	9.1*	9.2
	10 ft lb			35.4*	37.0*	26.1*	29.4*	20.1*	25.4*				19.8*	20.1*	30.4"
1.5 m t			15.7*	18.6*	11.7*	14.5*	9.2*	12.1*				8.8*	9.7*	9.2	
5 ft lb			33.9*	40.1*	25.2*	31.3*	19.7*	26.3*				19.4*	21.5*	30.4"	
0 m t			14.8*	14.8*	15.4*	19.0*	11.5*	14.8*				9.1*	10.8*	9.0	
0 ft lb			35.4*	35.4*	33.2*	41.0*	24.6*	32.0*				20.0*	23.9*	29.5"	
-1.5 m t	14.1*	14.1*	23.7*	23.7*	15.4*	18.4*	11.4*	14.4*				9.9*	12.4*	8.4	
-5 ft lb	32.5*	32.5*	51.2*	51.5*	33.1*	39.7*	24.6*	31.1*				21.8*	27.2*	27.7"	
-3.0 m t	26.2*	26.2*	21.2*	21.2*	15.7*	16.6*	11.7*	12.5*				11.7*	12.5*	7.5	
-10 ft lb	57.2*	57.2*	45.8*	45.8*	33.7*	35.7*						25.9*	27.5*	24.7"	
-4.5 m t			16.6*	16.6*	12.2*	12.2*						11.9*	11.9*	6.1	
-15 ft lb			35.4*	35.4*								26.1*	26.1*	19.8"	
-6.0 m t															
-20 ft lb															

Stick 2.90 m / 9'6"

Under-carriage	Height	3.0 m 10 ft		4.5 m 15 ft		6.0 m 20 ft		7.5 m 25 ft		9.0 m 30 ft		10.5 m 35 ft		m ft in	
		Can be slewed through 360°	In longitudinal position of undercarriage	Can be slewed through 360°	In longitudinal position of undercarriage	Can be slewed through 360°	In longitudinal position of undercarriage	Can be slewed through 360°	In longitudinal position of undercarriage	Can be slewed through 360°	In longitudinal position of undercarriage	Can be slewed through 360°	In longitudinal position of undercarriage		
LC-V	9.0 m t												7.7*	7.7*	6.9
	30 ft lb												17.3*	17.3*	22.2"
	7.5 m t							10.4*	10.4*				7.1*	7.1*	8.2
	25 ft lb							22.9*	22.9*				15.7*	15.7*	26.7"
	6.0 m t							10.9*	10.9*	7.8*	7.8*		6.9*	6.9*	9.0
	20 ft lb							23.7*	23.7*				15.1*	15.1*	29.5"
	4.5 m t			19.4*	19.4*	14.2*	14.2*	11.9*	11.9*	10.0*	10.8*		6.9*	6.9*	9.5
	15 ft lb			41.1*	41.1*	30.6*	30.6*	25.8*	25.8*	21.5*	23.5*		15.1*	15.1*	31.2"
	3.0 m t			14.1*	14.1*	16.5*	16.5*	12.7*	13.1*	9.8*	11.3*		7.1*	7.1*	9.8
	10 ft lb			37.1*	37.1*	35.5*	35.5*	27.2*	28.3*	21.0*	24.6*		15.6*	15.6*	32"
1.5 m t			11.9*	11.9*	16.5*	18.2*	12.2*	14.1*	9.5*	11.8*		7.5*	7.5*	9.8	
5 ft lb			29.1*	29.1*	35.5*	39.1*	26.2*	30.5*	20.4*	25.6*		16.6*	16.6*	32"	
0 m t			18.2*	18.2*	16.1*	18.8*	11.9*	14.7*	9.3*	12.0*		8.3*	8.3*	9.5	
0 ft lb			42.4*	42.4*	34.5*	40.7*	25.6*	31.7*	20.1*	26.0*		18.3*	18.3*	31.2"	
-1.5 m t	15.5*	15.5*	24.6*	24.7*	16.0*	18.6*	11.8*	14.5*				9.4*	9.6*	9.0	
-5 ft lb	34.9*	34.9*	52.8*	53.4*	34.3*	40.1*	25.3*	31.3*				20.8*	21.3*	29.6"	
-3.0 m t	26.0*	26.0*	22.4*	22.4*	16.1*	17.2*	11.9*	13.3*				10.9*	11.8*	8.2	
-10 ft lb	58.8*	58.8*	48.4*	48.4*	34.7*	37.0*	25.7*	28.4*				24.1*	26.0*	26.7"	
-4.5 m t	24.1*	24.1*	18.4*	18.4*	14.0*	14.0*						11.6*	11.6*	6.9	
-15 ft lb	51.6*	51.6*	39.4*	39.4*	29.6*	29.6*						25.6*	25.6*	22.4"	
-6.0 m t															
-20 ft lb															
HD	9.0 m t												7.8*	7.8*	6.9
	30 ft lb												17.4*	17.4*	22.2"
	7.5 m t							10.4*	10.4*				7.1*	7.1*	8.2
	25 ft lb							23.0*	23.0*				15.8*	15.8*	26.7"
	6.0 m t							10.9*	10.9*	7.2*	7.2*		6.9*	6.9*	9.0
	20 ft lb							23.6*	23.6*				15.2*	15.2*	29.5"
	4.5 m t			19.0*	19.0*	14.1*	14.1*	11.8*	11.8*	9.7*	10.7*		6.8*	6.8*	9.5
	15 ft lb			40.3*	40.3*	30.2*	30.2*	25.6*	25.6*	20.7*	23.4*		15.1*	15.1*	31.2"
	3.0 m t			15.0*	15.0*	16.4*	16.4*	12.2*	13.0*	9.4*	11.3*		7.0*	7.0*	9.8
	10 ft lb			39.5*	39.5*	35.1*	35.1*	26.2*	28.2*	20.1*	24.5*		15.5*	15.5*	32"
1.5 m t			11.7*	11.7*	15.9*	18.1*	11.7*	14.1*	9.1*	11.8*		7.5*	7.5*	9.8	
5 ft lb			28.7*	28.7*	34.1*	38.9*	25.2*	30.4*	19.6*	25.6*		16.5*	16.5*	32"	
0 m t			17.7*	17.7*	15.4*	18.8*	11.4*	14.6*	8.9*	12.0*		8.2*	8.2*	9.5	
0 ft lb			41.2*	41.2*	33.2*	40.6*	24.5*	31.6*	19.2*	26.0*		18.1*	18.1*	31.2"	
-1.5 m t	14.8*	14.8*	23.6*	24.8*	15.3*	18.6*	11.3*	14.6*				9.0*	9.5*	9.0	
-5 ft lb	33.4*	33.4*	50.6*	53.7*	32.9*	40.2*	24.3*	31.4*				19.7*	21.0*	29.6"	
-3.0 m t	25.2*	25.2*	22.6*	22.6*	15.4*	17.3*	11.4*	13.4*				10.3*	11.8*	8.2	
-10 ft lb	57.0*	57.0*	48.9*	48.9*	33.2*	37.3*	24.6*	28.8*				22.8*	26.0*	26.7"	
-4.5 m t	24.6*	24.6*	18.8*	18.8*	14.3*	14.3*						11.7*	11.7*	6.9	
-15 ft lb	52.8*	52.8*	40.2*	40.2*	30.4*	30.4*						25.7*	25.7*	22.4"	
-6.0 m t															
-20 ft lb															

↑ Height Can be slewed through 360° In longitudinal position of undercarriage Max. reach * Limited by hydr. capacity

The load values are quoted in tons (t) / lb x 1,000 at stick end (without bucket), and may be swung 360° on firm and even ground. Adjacent values are valid for the undercarriage when in the longitudinal position. Capacities are valid for 750 mm/30" wide track pads. Indicated loads are based on ISO 10567 standard and do not exceed 75% of tipping or 87% of hydraulic capacity (indicated via *). Without bucket cylinder, link and lever the lift capacities will increase by 825 kg/1,820 lb. Lifting capacity of the excavator is limited by machine stability and hydraulic capacity.

Stick 3.80 m / 12'6"

Under-carriage	Height	3.0 m 10 ft		4.5 m 15 ft		6.0 m 20 ft		7.5 m 25 ft		9.0 m 30 ft		10.5 m 35 ft		Max. reach		
		t	lb	t	lb	t	lb	t	lb	t	lb	t	lb	m	ft in	
LC-V	9.0 m 30 ft	t	lb											5.3*	5.3*	8.1
	7.5 m 25 ft	t	lb							6.9*	6.9*			5.0*	5.0*	9.2
	6.0 m 20 ft	t	lb					9.6*	9.6*	9.2*	9.2*			4.8*	4.8*	9.9
	4.5 m 15 ft	t	lb			12.5*	12.5*	10.8*	10.8*	9.8*	9.8*			4.8*	4.8*	10.4
	3.0 m 10 ft	t	lb	21.3*	21.3*	15.0*	15.0*	12.1*	12.1*	9.9	10.5*	6.2*	6.2*	5.0*	5.0*	10.6
	1.5 m 5 ft	t	lb	19.2*	19.2*	16.8	17.1*	12.3	13.4*	9.6	11.3*	6.4*	6.4*	5.2*	5.2*	10.6
	0 m 0 ft	t	lb	7.9*	7.9*	19.8*	19.8*	16.2	18.4*	11.9	14.3*	9.3	11.8*	5.7*	5.7*	10.4
	-1.5 m -5 ft	t	lb	14.0*	14.0*	24.4	25.1*	15.9	18.7*	11.7	14.6*	9.2	11.8*	6.5*	6.5*	9.9
	-3.0 m -10 ft	t	lb	31.5*	31.5*	52.4	55.6*	34.2	40.5*	25.2	31.4*	19.7	25.5*	14.3*	14.3*	32.6"
	-4.5 m -15 ft	t	lb	20.9*	20.9*	24.2*	24.2*	15.9	18.1*	11.7	14.1*	9.2	9.5*	7.8*	7.8*	9.2
	-6.0 m -20 ft	t	lb	21.6*	21.6*	15.9*	15.9*	11.3*	11.3*					10.6*	10.6*	6.4
	HD	9.0 m 30 ft	t	lb											5.4*	5.4*
7.5 m 25 ft		t	lb							6.5*	6.5*			5.0*	5.0*	9.2
6.0 m 20 ft		t	lb					9.5*	9.5*	9.2*	9.2*			4.8*	4.8*	9.9
4.5 m 15 ft		t	lb			12.3*	12.3*	10.7*	10.7*	9.7*	9.7*			4.8*	4.8*	10.4
3.0 m 10 ft		t	lb			20.9*	20.9*	14.8*	14.8*	12.0*	12.0*	6.1*	6.1*	4.9*	4.9*	10.6
1.5 m 5 ft		t	lb			19.5*	19.5*	16.2	17.0*	11.9	13.3*	9.2	11.2*	5.2*	5.2*	10.6
0 m 0 ft		t	lb	7.4*	7.4*	19.6*	19.6*	15.6	18.4*	11.5	14.2*	8.9	11.7*	5.7*	5.7*	10.4
-1.5 m -5 ft		t	lb	13.5*	13.5*	23.5	24.7*	15.3	18.8*	11.2	14.6*	8.8	11.8*	6.4*	6.4*	9.9
-3.0 m -10 ft		t	lb	30.5*	30.5*	50.3	55.7*	32.8	40.5*	24.1	31.4*	18.9	25.5*	14.2*	14.2*	32.6"
-4.5 m -15 ft		t	lb	20.3*	20.3*	23.6	24.4*	15.2	18.2*	11.2	14.1*	8.8	10.6*	7.7*	7.7*	9.2
-6.0 m -20 ft		t	lb	22.4*	22.4*	16.4*	16.4*	11.9*	11.9*					10.6*	10.6*	6.4

 Height
  Can be slewed through 360°
  In longitudinal position of undercarriage
  Max. reach
 * Limited by hydr. capacity

The load values are quoted in tons (t) / lb x 1,000 at stick end (without bucket), and may be swung 360° on firm and even ground. Adjacent values are valid for the undercarriage when in the longitudinal position. Capacities are valid for 750 mm / 30" wide track pads. Indicated loads are based on ISO 10567 standard and do not exceed 75% of tipping or 87% of hydraulic capacity (indicated via *). Without bucket cylinder, link and lever the lift capacities will increase by 825 kg / 1,820 lb. Lifting capacity of the excavator is limited by machine stability and hydraulic capacity.

Lift Capacities

with Mono Boom 6.70 m/22', Removable Counterweight 12.0 t/26,460 lb and Track Pads 750 mm/30"

Stick 2.35 m / 7'9"

Under-carriage	Height	3.0 m / 10 ft		4.5 m / 15 ft		6.0 m / 20 ft		7.5 m / 25 ft		9.0 m / 30 ft		10.5 m / 35 ft		Max. reach	m	
		Can be slewed through 360°	In longitudinal position of undercarriage	Can be slewed through 360°	In longitudinal position of undercarriage	Can be slewed through 360°	In longitudinal position of undercarriage	Can be slewed through 360°	In longitudinal position of undercarriage	Can be slewed through 360°	In longitudinal position of undercarriage	Can be slewed through 360°	In longitudinal position of undercarriage			
LC-V	9.0 m t													10.2*	10.2*	6.2
	30 ft lb															
	7.5 m t							11.5*	11.5*					9.2*	9.2*	7.6
	25 ft lb													20.4*	20.4*	24.6"
	6.0 m t						13.2*	13.2*	11.7*	11.7*				8.9*	8.9*	8.4
	20 ft lb						28.5*	28.5*	25.7*	25.7*				19.6*	19.6*	27.7"
	4.5 m t			21.8*	21.8*	15.2*	15.2*	12.6*	12.6*	9.3*	9.3*			8.9*	8.9*	9.0
	15 ft lb			46.1*	46.1*	32.9*	32.9*	27.5*	27.5*					19.5*	19.5*	29.5"
	3.0 m t					17.3*	17.3*	13.3*	13.3*	10.3	11.8*			9.2*	9.2*	9.2
	10 ft lb					37.4*	37.4*	28.7*	29.7*	22.2*	25.8*			20.2*	20.2*	30.4"
HD	1.5 m t					17.3	18.7*	12.9	14.5*	10.1	12.2*			9.8	9.8*	9.2
	5 ft lb					37.3	40.4*	27.8	31.5*	21.8	26.4*			21.5	21.6*	30.4"
	0 m t			15.8*	15.8*	17.0	19.0*	12.6	14.8*					10.1	10.9*	9.0
	0 ft lb			37.5*	37.5*	36.7	41.1*	27.3	32.1*					22.3	24.1*	29.5"
	-1.5 m t	15.4*	15.4*	23.6*	23.6*	17.0	18.3*	12.6	14.4*					11.0	12.4*	8.4
	-5 ft lb	35.4*	35.4*	51.3*	51.3*	36.7	39.6*	27.2	31.0*					24.4	27.3*	27.7"
	-3.0 m t	26.0*	26.0*	21.0*	21.0*	16.4*	16.4*							12.5*	12.5*	7.5
	-10 ft lb	56.7*	56.7*	45.4*	45.4*	35.4*	35.4*							27.5*	27.5*	24.7"
	-4.5 m t			16.1*	16.1*									11.8*	11.8*	7.5
	-15 ft lb			34.4*	34.4*									25.9*	25.9*	19.8"
-6.0 m t																
-20 ft lb																
9.0 m t														10.3*	10.3*	6.2
30 ft lb																
7.5 m t							10.5*	10.5*					9.3*	9.3*	7.6	
25 ft lb													20.5*	20.5*	24.6"	
6.0 m t						13.1*	13.1*	11.7*	11.7*				8.9*	8.9*	8.4	
20 ft lb						28.3*	28.3*	25.6*	25.6*				19.6*	19.6*	27.7"	
4.5 m t			21.3*	21.3*	15.1*	15.1*	12.6*	12.6*					8.9*	8.9*	9.0	
15 ft lb			45.2*	45.2*	32.5*	32.5*	27.3*	27.3*					19.5*	19.5*	29.5"	
3.0 m t					17.2*	17.2*	12.8	13.6*	9.9	11.8*			9.1*	9.1*	9.2	
10 ft lb					37.1*	37.1*	27.7	29.5*	21.4	25.4*			20.1*	20.1*	30.4"	
1.5 m t					16.7	18.6*	12.4	14.5*	9.7	12.1*			9.4	9.7*	9.2	
5 ft lb					36.0	40.2*	26.8	31.4*	21.0	26.4*			20.7	21.5*	30.4"	
0 m t			14.8*	14.8*	16.4	19.0*	12.1	14.8*					9.7	10.8*	9.0	
0 ft lb			35.4*	35.4*	35.3	41.1*	26.2	32.1*					21.3	23.9*	29.5"	
-1.5 m t	14.1*	14.1*	23.7*	23.7*	16.4	18.4*	12.1	14.4*					10.5	12.4*	8.4	
-5 ft lb	32.5*	32.5*	51.6*	51.6*	35.3	39.8*	26.2	31.2*					23.2	27.3*	27.7"	
-3.0 m t	26.2*	26.2*	21.2*	21.2*	16.6	16.6*	12.4	12.5*					12.4	12.5*	7.5	
-10 ft lb	57.3*	57.3*	45.9*	45.9*	35.8	35.8*							27.5	27.5*	24.7"	
-4.5 m t			16.6*	16.6*	12.2*	12.2*							11.9*	11.9*	7.5	
-15 ft lb			35.4*	35.4*									26.1*	26.1*	19.8"	
-6.0 m t																
-20 ft lb																

Stick 2.90 m / 9'6"

Under-carriage	Height	3.0 m / 10 ft		4.5 m / 15 ft		6.0 m / 20 ft		7.5 m / 25 ft		9.0 m / 30 ft		10.5 m / 35 ft		Max. reach	m	
		Can be slewed through 360°	In longitudinal position of undercarriage	Can be slewed through 360°	In longitudinal position of undercarriage	Can be slewed through 360°	In longitudinal position of undercarriage	Can be slewed through 360°	In longitudinal position of undercarriage	Can be slewed through 360°	In longitudinal position of undercarriage	Can be slewed through 360°	In longitudinal position of undercarriage			
LC-V	9.0 m t													7.7*	7.7*	6.9
	30 ft lb													17.3*	17.3*	22.2"
	7.5 m t								10.4*	10.4*				7.1*	7.1*	8.2
	25 ft lb								23.0*	23.0*				15.7*	15.7*	26.7"
	6.0 m t								10.9*	10.9*	7.8*	7.8*		6.9*	6.9*	9.0
	20 ft lb								23.8*	23.8*				15.1*	15.1*	29.5"
	4.5 m t					19.4*	19.4*	14.2*	14.2*	11.9*	11.9*	10.6	10.8*	6.9*	6.9*	9.5
	15 ft lb					41.3*	41.3*	30.7*	30.7*	25.9*	25.9*	22.8	23.6*	15.1*	15.1*	31.2"
	3.0 m t					14.1*	14.1*	16.5*	16.5*	13.1*	13.1*	10.3	11.3*	7.1*	7.1*	9.8
	10 ft lb					37.1*	37.1*	35.6*	35.6*	28.4*	28.4*	22.2	24.7*	15.6*	15.6*	32"
1.5 m t					11.9*	11.9*	17.4	18.2*	12.9	14.1*	10.1	11.8*	7.5*	7.5*	9.8	
5 ft lb					29.1*	29.1*	37.6	39.2*	27.8	30.6*	21.7	25.7*	16.5*	16.5*	32"	
0 m t					18.2*	18.2*	17.0	18.8*	12.6	14.7*	9.9	12.0*	8.3*	8.3*	9.5	
0 ft lb					42.4*	42.4*	36.7	40.8*	27.1	31.8*	21.4	26.0*	18.3*	18.3*	31.2"	
-1.5 m t	15.5*	15.5*	24.7*	24.7*	16.9	18.6*	12.5	14.5*					9.6*	9.6*	9.0	
-5 ft lb	34.9*	34.9*	53.6*	53.6*	36.4	40.2*	26.9	31.4*					21.3*	21.3*	29.6"	
-3.0 m t	26.0*	26.0*	22.4*	22.4*	17.0	17.2*	12.6	13.3*					11.5	11.8*	8.2	
-10 ft lb	58.8*	58.8*	48.5*	48.5*	36.8	37.1*	27.3	28.5*					25.6	26.0*	26.7"	
-4.5 m t			24.1*	24.1*	18.4*	18.4*	14.0*	14.0*					11.6*	11.6*	6.9	
-15 ft lb			51.7*	51.7*	39.5*	39.5*	29.7*	29.7*					25.6*	25.6*	22.4"	
-6.0 m t																
-20 ft lb																
9.0 m t														7.8*	7.8*	6.9
30 ft lb														17.4*	17.4*	22.2"
7.5 m t									10.4*	10.4*				7.1*	7.1*	8.2
25 ft lb									23.0*	23.0*				15.8*	15.8*	26.7"
6.0 m t									10.9*	10.9*	7.2*	7.2*		6.9*	6.9*	9.0
20 ft lb									23.7*	23.7*				15.2*	15.2*	29.5"
4.5 m t					19.0*	19.0*	14.1*	14.1*	11.8*	11.8*	10.2	10.7*	6.8*	6.8*	9.5	
15 ft lb					40.5*	40.5*	30.4*	30.4*	25.7*	25.7*	22.0	23.5*	15.1*	15.1*	31.2"	
3.0 m t					15.0*	15.0*	16.4*	16.4*	12.9	13.0*	9.9	11.3*	7.0*	7.0*	9.8	
10 ft lb					39.5*	39.5*	35.3*	35.3*	27.8	28.3*	21.4	24.6*	15.5*	15.5*	32"	
1.5 m t					11.7*	11.7*	16.8	18.1*	12.4	14.1*	9.7	11.8*	7.5*	7.5*	9.8	
5 ft lb					28.7*	28.7*	36.3	39.1*	26.8	30.5*	20.9	25.6*	16.5*	16.5*	32"	
0 m t					17.7*	17.7*	16.4	18.8*	12.1	14.6*	9.5	12.0*	8.2*	8.2*	9.5	
0 ft lb					41.2*	41.2*	35.3	40.8*	26.1	31.7*	20.5	26.0*	18.1*	18.1*	31.2"	
-1.5 m t	14.8*	14.8*	24.8*	24.8*	16.2	18.6*	12.0	14.6*					9.5*	9.5*	9.0	
-5 ft lb	33.4*	33.4*	53.8	53.8*	35.0	40.3*	25.9	31.5*					21.0	21.0*	29.6"	
-3.0 m t	25.2*	25.2*	22.6*	22.6*	16.4	17.3*	12.1	13.4*					10.9	11.8*	8.2	
-10 ft lb	57.0*	57.0*	49.0*	49.0*	35.3	37.4*	26.1	28.8*					24.3	26.0*	26.7"	
-4.5 m t			24.6*	24.6*	18.8*	18.8*	14.3*	14.3*					11.7*	11.7*	6.9	
-15 ft lb			52.9*	52.9*	40.3*	40.3*	30.4*	30.4*					25.7*	25.7*	22.4"	
-6.0 m t																
-20 ft lb																

Height
 Can be slewed through 360°
 In longitudinal position of undercarriage
 Max. reach
 * Limited by hydr. capacity

The load values are quoted in tons (t) / lb x 1,000 at stick end (without bucket), and may be swung 360° on firm and even ground. Adjacent values are valid for the undercarriage when in the longitudinal position. Capacities are valid for 750 mm/30" wide track pads. Indicated loads are based on ISO 10567 standard and do not exceed 75% of tipping or 87% of hydraulic capacity (indicated via *). Without bucket cylinder, link and lever the lift capacities will increase by 825 kg/1,820 lb. Lifting capacity of the excavator is limited by machine stability and hydraulic capacity.

Stick 3.80 m / 12'6"

Under-carriage	Height	3.0 m 10 ft		4.5 m 15 ft		6.0 m 20 ft		7.5 m 25 ft		9.0 m 30 ft		10.5 m 35 ft		Max. reach		
		t	lb	t	lb	t	lb	t	lb	t	lb	t	lb	m	ft	in
LC-V	9.0 m 30 ft													5.4*	5.4*	8.1
	7.5 m 25 ft									6.9*	6.9*			5.0*	5.0*	9.2
	6.0 m 20 ft							9.6*	9.6*	9.2*	9.2*			4.8*	4.8*	9.9
	4.5 m 15 ft					12.5*	12.5*	10.8*	10.8*	9.8*	9.8*			4.8*	4.8*	10.4
	3.0 m 10 ft			21.3*	21.3*	15.0*	15.0*	12.1*	12.1*	10.4	10.5*	6.2*	6.2*	5.0*	5.0*	10.6
	1.5 m 5 ft			19.2*	19.2*	17.1*	17.1*	13.0	13.4*	10.1	11.3*	6.4*	6.4*	5.2*	5.2*	10.6
	0 m 0 ft	7.9*	7.9*	19.8*	19.8*	17.1	18.4*	12.6	14.3*	9.9	11.8*			5.7*	5.7*	10.4
	-1.5 m -5 ft	14.0*	14.0*	25.1*	25.1*	16.8	18.7*	12.4	14.6*	9.7	11.8*			6.5*	6.5*	9.9
	-3.0 m -10 ft	20.9*	20.9*	24.2*	24.2*	16.8	18.1*	12.4	14.1*	9.5*	9.5*			7.8*	7.8*	9.2
	-4.5 m -15 ft	29.9*	29.9*	21.3*	21.3*	16.1*	16.1*	12.2*	12.2*					10.5*	10.5*	8.1
	-6.0 m -20 ft	21.6*	21.6*	15.9*	15.9*	11.3*	11.3*							10.6*	10.6*	6.4
	9.0 m 30 ft														5.4*	5.4*
7.5 m 25 ft									6.5*	6.5*				5.0*	5.0*	9.2
6.0 m 20 ft							9.5*	9.5*	9.2*	9.2*				4.8*	4.8*	9.9
4.5 m 15 ft					12.3*	12.3*	10.7*	10.7*	9.7*	9.7*				4.8*	4.8*	10.4
3.0 m 10 ft			20.9*	20.9*	14.8*	14.8*	12.0*	12.0*	10.1	10.5*	6.1*	6.1*	4.9*	4.9*	10.6	
1.5 m 5 ft			19.5*	19.5*	17.0*	17.0*	12.6	13.3*	9.7	11.2*	6.5*	6.5*	5.2*	5.2*	10.6	
0 m 0 ft	7.4*	7.4*	19.6*	19.6*	16.5	18.4*	12.1	14.2*	9.5	11.7*			5.7*	5.7*	10.4	
-1.5 m -5 ft	13.5*	13.5*	24.7*	24.7*	16.2	18.8*	11.9	14.6*	9.3	11.8*			6.4*	6.4*	9.9	
-3.0 m -10 ft	20.3*	20.3*	24.4*	24.4*	16.2	18.2*	11.9	14.1*	9.4	10.6*			7.7*	7.7*	9.2	
-4.5 m -15 ft	29.2*	29.2*	21.6*	21.6*	16.3*	16.3*	12.1	12.4*					10.3*	10.3*	8.1	
-6.0 m -20 ft	22.4*	22.4*	16.4*	16.4*	11.9*	11.9*							10.6*	10.6*	6.4	

 Height
  Can be slewed through 360°
  In longitudinal position of undercarriage
  Max. reach
 * Limited by hydr. capacity

The load values are quoted in tons (t) / lb x 1,000 at stick end (without bucket), and may be swung 360° on firm and even ground. Adjacent values are valid for the undercarriage when in the longitudinal position. Capacities are valid for 750 mm / 30" wide track pads. Indicated loads are based on ISO 10567 standard and do not exceed 75% of tipping or 87% of hydraulic capacity (indicated via *). Without bucket cylinder, link and lever the lift capacities will increase by 825 kg / 1,820 lb. Lifting capacity of the excavator is limited by machine stability and hydraulic capacity.

Lift Capacities

with Mono Boom 7.60 m/24'11", Counterweight 11.0 t/24,250 lb and Track Pads 750 mm/30"

Stick 2.35 m / 7'9"

Under-carriage	Height	3.0 m / 10 ft		4.5 m / 15 ft		6.0 m / 20 ft		7.5 m / 25 ft		9.0 m / 30 ft		10.5 m / 35 ft		Max. reach	
		Can be slewed through 360°	In longitudinal position of undercarriage	Can be slewed through 360°	In longitudinal position of undercarriage	Can be slewed through 360°	In longitudinal position of undercarriage	Can be slewed through 360°	In longitudinal position of undercarriage	Can be slewed through 360°	In longitudinal position of undercarriage	Can be slewed through 360°	In longitudinal position of undercarriage		
LC-V	10.5 m t													8.6° 8.6°	
	35 ft lb													8.6° 8.6°	
	9.0 m t							10.6°	10.6°					9.8° 9.8° 7.5	
	30 ft lb							21.9° 21.9° 24'4"						21.9° 21.9° 24'4"	
	7.5 m t							10.6°	10.6°					9.1° 9.1° 8.7	
	25 ft lb							23.1° 23.1°						20.2° 20.2° 28'4"	
	6.0 m t					13.5°	13.5°	11.3°	11.3°	9.9	10.2°				8.9° 8.9° 9.5
	20 ft lb			39.5°	39.5°	29.0°	29.0°	24.4°	24.4°	21.3	22.2°				19.6° 19.6° 31'
	4.5 m t					15.7°	15.7°	12.3°	12.3°	9.6	10.6°				8.2 8.9° 10.0
	15 ft lb					33.6°	33.6°	26.5°	26.5°	20.7	23.0°				18.1 19.5° 32'7"
HD	3.0 m t					15.7°	17.5°	11.8	13.3°	9.3	11.1°				7.8 9.1° 10.2
	10 ft lb					34.0	37.6°	25.6	28.7°	20.0	24.0°				17.1 20.0° 33'5"
	1.5 m t					15.2	17.1°	11.4	13.9°	9.0	11.4°				7.7 9.6° 10.2
	5 ft lb					32.9	39.1°	24.6	30.1°	19.4	24.8°				16.9 21.1° 33'5"
	0 m t					15.1	17.7°	11.2	14.0°	8.9	11.5°				7.9 10.2° 9.9
	0 ft lb					32.6	38.5°	24.2	30.4°	19.1	24.9°				17.3 22.5° 32'7"
	-1.5 m t			14.5°	14.5°	15.2	16.9°	11.2	13.6°	8.9	11.0°				8.5 10.3° 9.5
	-5 ft lb			34.4°	34.4°	32.8	36.6°	24.1	29.4°	19.2	23.7°				18.7 22.6° 31'
	-3.0 m t			18.2°	18.2°	15.3°	15.3°	11.4	12.4°						9.7 10.1° 8.7
	-10 ft lb			39.8°	39.8°	33.2°	33.2°	24.6	26.7°						21.4 22.3° 28'5"
-4.5 m t			15.0°	15.0°	12.5°	12.5°								9.6° 9.6° 7.5	
-15 ft lb			32.5°	32.5°	26.9°	26.9°								20.9° 20.9° 24'4"	
-6.0 m t															
-20 ft lb															
LC-V	10.5 m t													9.9° 9.9° 7.5	
	35 ft lb													22.1° 22.1° 24'4"	
	9.0 m t							10.7°	10.7°					9.2° 9.2° 8.7	
	30 ft lb							23.0°	23.0°					20.3° 20.3° 28'4"	
	7.5 m t							10.5°	10.5°					8.7 8.9° 9.5	
	25 ft lb							23.0°	23.0°					19.3 19.6° 31'	
	6.0 m t					13.3°	13.3°	11.2°	11.2°	9.5	10.1°				7.9 8.9° 10.0
	20 ft lb			38.6°	38.6°	28.7°	28.7°	24.3°	24.3°	20.4	22.2°				17.4 19.5° 32'7"
	4.5 m t					15.5°	15.5°	12.0	12.2°	9.2	10.5°				7.4 9.1° 10.2
	15 ft lb					33.3°	33.3°	25.9	26.4°	19.9	22.9°				16.4 20.0° 33'5"
HD	3.0 m t					15.1	17.4°	11.4	13.2°	8.9	11.0°				7.3 9.5° 10.2
	10 ft lb					32.7	37.4°	24.6	28.5°	19.2	24.0°				16.1 21.0° 33'5"
	1.5 m t					14.6	16.8°	10.9	13.9°	8.6	11.4°				7.5 10.2° 9.9
	5 ft lb					31.5	39.1°	23.6	30.0°	18.6	24.8°				8.0 10.3° 9.5
	0 m t					14.5	17.8°	10.7	14.0°	8.5	11.5°				17.7 22.6° 31'
	0 ft lb					31.2	38.6°	23.1	30.4°	18.3	24.9°				18.3 23.8°
	-1.5 m t			13.2°	13.2°	14.6	16.9°	10.7	13.6°	8.5	11.1°				9.1 10.2° 8.7
	-5 ft lb			31.8°	31.8°	31.4	36.8°	23.1	29.6°	18.3	23.8°				20.3 22.4° 28'5"
	-3.0 m t			18.4°	18.4°	14.8	15.4°	10.9	12.5°						9.6° 9.6° 7.5
	-10 ft lb			40.1°	40.1°	31.9	33.5°	23.5	26.9°						21.1° 21.1° 24'4"
-4.5 m t			15.3°	15.3°	12.8°	12.8°								9.6° 9.6° 7.5	
-15 ft lb			33.1°	33.1°	27.4°	27.4°								21.1° 21.1° 24'4"	
-6.0 m t															
-20 ft lb															

Stick 2.90 m / 9'6"

Under-carriage	Height	3.0 m / 10 ft		4.5 m / 15 ft		6.0 m / 20 ft		7.5 m / 25 ft		9.0 m / 30 ft		10.5 m / 35 ft		Max. reach
		Can be slewed through 360°	In longitudinal position of undercarriage	Can be slewed through 360°	In longitudinal position of undercarriage	Can be slewed through 360°	In longitudinal position of undercarriage	Can be slewed through 360°	In longitudinal position of undercarriage	Can be slewed through 360°	In longitudinal position of undercarriage	Can be slewed through 360°	In longitudinal position of undercarriage	
LC-V	10.5 m t													8.6° 8.6°
	35 ft lb													8.6° 8.6°
	9.0 m t									9.6°	9.6°			7.5° 7.5° 8.2
	30 ft lb								21.3°	21.3°			16.7° 16.7° 26'7"	
	7.5 m t								9.8°	9.8°	9.3°	9.3°	7.1° 7.1° 9.3	
	25 ft lb								21.4°	21.4°	20.3°	20.3°	15.6° 15.6° 30'4"	
	6.0 m t					16.5°	16.5°	12.5°	12.5°	10.6°	10.6°	9.6°	9.6°	6.9° 6.9° 10.0
	20 ft lb					36.3°	36.3°	27.0°	27.0°	23.0°	23.0°	20.9°	20.9°	15.1° 15.1° 32'10"
	4.5 m t					14.7°	14.7°	11.7°	11.7°	9.6	10.1°	7.2°	7.2°	6.9° 6.9° 10.5
	15 ft lb					31.6°	31.6°	25.3°	25.3°	20.8	21.9°			15.1° 15.1° 34'5"
HD	3.0 m t					16.0	16.7°	11.9	12.8°	9.3	10.7°			7.0° 7.0° 10.7
	10 ft lb					34.6	36.0°	25.8	27.7°	20.0	23.2°	15.9	17.6°	15.5° 15.5° 35'1"
	1.5 m t					15.3	17.8°	11.4	13.6°	9.0	11.2°	7.3	9.6°	7.1 7.4° 10.7
	5 ft lb					33.1	38.4°	24.7	29.8°	19.3	24.2°	15.6	17.8°	15.6 16.2° 35'1"
	0 m t					15.1	17.9°	11.1	13.9°	8.8	11.4°			7.2 8.0° 10.5
	0 ft lb					32.5	38.7°	24.1	30.2°	18.9	24.6°			15.9 17.6° 34'5"
	-1.5 m t					15.7°	15.7°	15.1	17.3°	11.1	13.7°	8.7	11.1°	7.7 9.0° 10.0
	-5 ft lb					36.3°	36.3°	32.5	37.5°	23.9	29.7°	18.8	24.1°	17.0 19.8° 32'10"
	-3.0 m t			17.8°	17.8°	19.9°	19.9°	15.3	16.0°	11.2	12.8°	8.9	10.1°	8.7 9.6° 9.3
	-10 ft lb			40.2°	40.2°	43.2°	43.2°	32.9	34.6°	24.1	27.7°	19.3	21.4°	19.2 21.2° 30'5"
-4.5 m t			20.2°	20.2°	16.9°	16.9°	13.7°	13.7°	10.7°	10.7°			9.3° 9.3° 8.2	
-15 ft lb			43.8°	43.8°	36.5°	36.5°	29.5°	29.5°	22.7°	22.7°			20.5° 20.5° 26'8"	
-6.0 m t							9.2°	9.2°					8.1° 8.1° 6.6	
-20 ft lb													19.6° 19.6° 21'1"	
LC-V	10.5 m t													9.6° 9.6°
	35 ft lb													7.6° 7.6° 8.2
	9.0 m t									9.6°	9.6°			16.9° 16.9° 26'7"
	30 ft lb								21.3°	21.3°			16.9° 16.9° 26'7"	
	7.5 m t									9.8°	9.8°	9.3°	9.3°	7.1° 7.1° 9.3
	25 ft lb								21.4°	21.4°	18.9°	18.9°	15.7° 15.7° 30'4"	
	6.0 m t					12.4°	12.4°	10.5°	10.5°	9.5°	9.5°	6.9° 6.9° 10.0		
	20 ft lb					26.7°	26.7°	22.9°	22.9°	20.6	20.8°			15.1° 15.1° 32'10"
	4.5 m t					14.5°	14.5°	11.6°	11.6°	9.3	10.0°			6.8° 6.8° 10.5
	15 ft lb					31.3°	31.3°	25.1°	25.1°	20.0	21.9°			15.1° 15.1° 34'5"
HD	3.0 m t					15.4	16.6°	11.5	12.7°	8.9	10.6°	7.1	9.4°	6.9 7.0° 10.7
	10 ft lb					33.3	35.7°	24.8	27.5°	19.2	23.1°	15.2	17.2°	15.1 15.4° 35'1"
	1.5 m t					14.7	17.7°	11.0	13.6°	8.6	11.1°	6.9	9.6°	6.7 7.3° 10.7
	5 ft lb					31.7	38.3°	23.7	29.3°	18.5	24.2°	14.9	18.1°	14.9 16.2° 35'1"
	0 m t					14.4	17.9°	10.7	13.9°	8.4	11.4°			6.9 7.9° 10.5
	0 ft lb					31.1	38.8°	23.0	30.2°	18.1	24.6°			15.2 17.5° 34'5"
	-1.5 m t					15.0°	15.0°	14.4	17.3°	10.6	13.8°	8.3	11.2°	7.3 8.9° 10.0
	-5 ft lb					34.8°	34.8°	31.0	37.6°	22.8	29.8°	18.0	24.2°	16.1 19.6° 32'10"
	-3.0 m t			17.1°	17.1°	20.0°	20.0°	14.6	16.1°	10.7	12.9°	8.5	10.2°	8.2 9.6° 9.3
	-10 ft lb			38.7°	38.7°	43.5°	43.5°	31.4	34.9°	23.0	27.9°	18.3	21.7°	18.1 21.2° 30'5"
-4.5 m t			20.5°	20.5°	17.1°	17.1°	13.9°	13.9°	10.9°	10.9°			9.4° 9.4° 8.2	
-15 ft lb			44.5°	44.5°	37.0°	37.0°	29.9°	29.9°	23.3°	23.3°			20.6° 20.6° 26'8"	
-6.0 m t					12.3°	12.3°	9.6°	9.6°					8.2° 8.2° 6.6	
-20 ft lb							19.8°	19.8°					17.8° 17.8° 21'1"	

Stick 3.80 m / 12'6"

Under-carriage	↕	3.0 m 10 ft		4.5 m 15 ft		6.0 m 20 ft		7.5 m 25 ft		9.0 m 30 ft		10.5 m 35 ft		 m ft in		
		↕	↕	↕	↕	↕	↕	↕	↕	↕	↕	↕	↕	↕	↕	↕
LC-V	10.5 m t													5.8*	5.8*	8.0
	35 ft lb													13,0*	13,0*	25'6"
	9.0 m t									7.9*	7.9*			5.2*	5.2*	9.3
	30 ft lb									14,6*	14,6*			11,6*	11,6*	30'4"
	7.5 m t									8.3*	8.3*			4.9*	4.9*	10.3
	25 ft lb									18,2*	18,2*			10,9*	10,9*	33'7"
	6.0 m t							9.5*	9.5*	8.7*	8.7*	7.9	8.3*	4.8*	4.8*	11.0
	20 ft lb							20,7*	20,7*	19,0*	19,0*	16,0*	16,0*	10,6*	10,6*	35'10"
	4.5 m t			18.5*	18.5*	13.2*	13.2*	10.7*	10.7*	9.3*	9.3*	7.7	8.5*	4.8*	4.8*	11.4
	15 ft lb			39,3*	39,3*	28,4*	28,4*	23,2*	23,2*	20,3*	20,3*	16,5	18,6*	10,6*	10,6*	37'4"
	3.0 m t					15.4*	15.4*	12.0*	12.0*	9.4	10.1*	7.5	8.9*	4.9*	4.9*	11.6
	10 ft lb					33,2*	33,2*	25,9*	25,9*	20,3	21,9*	16,1	19,4*	10,8*	10,8*	38'
	1.5 m t					15.6	17.1*	11.6	13.0*	9.0	10.7*	7.2	9.2*	5.2*	5.2*	11.6
	5 ft lb					33,8	36,8*	25,0	28,2*	19,5	23,2*	15,6	20,1*	11,3*	11,3*	38'
	0 m t			9.9*	9.9*	15.1	17.8*	11.2	13.7*	8.7	11.1*	7.1	9.4*	5.5*	5.5*	11.4
	0 ft lb			23,0*	23,0*	32,6	38,5*	24,1	29,6*	18,9	24,1*	15,3	20,4*	12,2*	12,2*	37'4"
-1.5 m t	8.7*	8.7*	15.3*	15.3*	15.0	17.7*	11.0	13.8*	8.6	11.2*	7.0	9.3*	6.1*	6.1*	10.9	
-5 ft lb	19,6*	19,6*	35,0*	35,0*	32,2	38,3*	23,7	29,9*	18,6	24,3*	15,2	20,0*	13,5*	13,5*	35'11"	
-3.0 m t	14.9*	14.9*	22.0*	22.0*	15.0	16.9*	11.0	13.3*	8.6	10.8*			7.1*	7.1*	10.3	
-10 ft lb	33,5*	33,5*	47,7*	47,7*	32,4	36,5*	23,7	28,8*	18,6	23,2*			15,7*	15,7*	33'7"	
-4.5 m t	21.9*	21.9*	19.5*	19.5*	15.2*	15.2*	11.2	12.1*	8.9	9.3*			8.6	8.6*	9.3	
-15 ft lb	49,7*	49,7*	42,1*	42,1*	32,8*	32,8*	24,1	25,9*	19,2	19,3*			19,2	19,3*	30'4"	
-6.0 m t	20.0*	20.0*	15.6*	15.6*	12.2*	12.2*	9.1*	9.1*					8.3*	8.3*	7.9	
-20 ft lb			33,2*	33,2*	26,0*	26,0*	18,5*	18,5*					18,2*	18,2*	25'7"	
HD	10.5 m t													5.9*	5.9*	8.0
	35 ft lb													13,2*	13,2*	25'6"
	9.0 m t									7.5*	7.5*			5.3*	5.3*	9.3
	30 ft lb									13,5*	13,5*			11,7*	11,7*	30'4"
	7.5 m t									8.3*	8.3*			5.0*	5.0*	10.3
	25 ft lb									18,2*	18,2*			11,0*	11,0*	33'7"
	6.0 m t						9.5*	9.5*	8.7*	8.7*	7.5	8.2*	4.8*	4.8*	11.0	
	20 ft lb						20,6*	20,6*	18,9*	18,9*	15,5*	15,5*	10,6*	10,6*	35'10"	
	4.5 m t			18.1*	18.1*	13.0*	13.0*	10.6*	10.6*	9.3*	9.3*	7.4	8.5*	4.8*	4.8*	11.4
	15 ft lb			38,6*	38,6*	28,0*	28,0*	23,0*	23,0*	20,2*	20,2*	15,8	18,6*	10,6*	10,6*	37'4"
	3.0 m t					15.3*	15.3*	11.7	11.9*	9.0	10.0*	7.1	8.9*	4.9*	4.9*	11.6
	10 ft lb					32,9*	32,9*	25,3	25,7*	19,5	21,8*	15,4	19,3*	10,8*	10,8*	38'
	1.5 m t					15.0	17.0*	11.1	13.0*	8.6	10.7*	6.9	9.2*	5.1*	5.1*	11.6
	5 ft lb					32,5	36,6*	24,0	28,1*	18,7	23,2*	14,9	20,1*	11,3*	11,3*	38'
	0 m t			9.6*	9.6*	14.5	17.8*	10.7	13.6*	8.4	11.1*	6.8	9.4*	5.5*	5.5*	11.4
	0 ft lb			22,3*	22,3*	31,3	38,4*	23,1	29,5*	18,0	24,1*	14,6	20,4*	12,1*	12,1*	37'4"
-1.5 m t	8.2*	8.2*	14.9*	14.9*	14.3	17.7*	10.5	13.8*	8.2	11.2*	6.7	9.3*	6.1*	6.1*	10.9	
-5 ft lb	18,6*	18,6*	34,1*	34,1*	30,8	38,4*	22,6	29,9*	17,7	24,3*	14,5	20,0*	13,4*	13,4*	35'11"	
-3.0 m t	14.4*	14.4*	21.7*	21.7*	14.3	17.0*	10.5	13.4*	8.2	10.8*			7.0	7.0*	10.3	
-10 ft lb	32,6*	32,6*	48,0*	48,0*	30,9	36,7*	22,6	28,9*	17,7	23,3*			15,5	15,5*	33'7"	
-4.5 m t	21.4*	21.4*	19.7*	19.7*	14.6	15.4*	10.6	12.2*	8.4	9.4*			8.1	8.6*	9.3	
-15 ft lb	48,4*	48,4*	42,6*	42,6*	31,5	33,2*	23,0	26,2*	18,3	19,8*			18,1	19,3*	30'4"	
-6.0 m t	20.5*	20.5*	15.9*	15.9*	12.5*	12.5*	9.4*	9.4*					8.4*	8.4*	7.9	
-20 ft lb			43,7*	43,7*	33,9*	33,9*	26,6*	26,6*	19,4*	19,4*			18,3*	18,3*	25'7"	

 Height
  Can be slewed through 360°
  In longitudinal position of undercarriage
  Max. reach
 * Limited by hydr. capacity

The load values are quoted in tons (t) / lb x 1,000 at stick end (without bucket), and may be swung 360° on firm and even ground. Adjacent values are valid for the undercarriage when in the longitudinal position. Capacities are valid for 750 mm / 30" wide track pads. Indicated loads are based on ISO 10567 standard and do not exceed 75% of tipping or 87% of hydraulic capacity (indicated via *). Without bucket cylinder, link and lever the lift capacities will increase by 825 kg / 1,820 lb. Lifting capacity of the excavator is limited by machine stability and hydraulic capacity.

Lift Capacities

with Mono Boom 7.60 m/24'11", Removable Counterweight 12.0 t/26,460 lb and Track Pads 750 mm/30"

Stick 2.35 m / 7'9"

Under-carriage	Height	3.0 m / 10 ft		4.5 m / 15 ft		6.0 m / 20 ft		7.5 m / 25 ft		9.0 m / 30 ft		10.5 m / 35 ft		m
		Can be slewed through 360°	In longitudinal position of undercarriage	Can be slewed through 360°	In longitudinal position of undercarriage	Can be slewed through 360°	In longitudinal position of undercarriage	Can be slewed through 360°	In longitudinal position of undercarriage	Can be slewed through 360°	In longitudinal position of undercarriage	Can be slewed through 360°	In longitudinal position of undercarriage	
LC-V	10.5 m t													
	35 ft lb													
	9.0 m t							10.6*	10.6*			9.8*	9.8*	7.5
	30 ft lb											21.9*	21.9*	24'4"
	7.5 m t							10.6*	10.6*			9.1*	9.1*	8.7
	25 ft lb											20.2*	20.2*	28'4"
	6.0 m t					13.5*	13.5*	11.3*	11.3*	10.2*	10.2*	8.9*	8.9*	9.5
	20 ft lb			39.5*	39.5*	29.0*	29.0*	24.4*	24.4*	22.2*	22.2*	19.6*	19.6*	31'
	4.5 m t					15.7*	15.7*	12.3*	12.3*	10.1*	10.6*	8.7*	8.9*	10.0
	15 ft lb					33.6*	33.6*	26.5*	26.5*	21.9*	23.0*	19.1*	19.5*	32'7"
HD	3.0 m t					16.6*	17.5*	12.5*	13.3*	9.8*	11.1*	8.2*	9.1*	10.2
	10 ft lb					36.0*	37.6*	27.0*	28.7*	21.2*	24.0*	18.2*	20.0*	33'5"
	1.5 m t					16.2*	17.1*	12.1*	13.9*	9.5*	11.4*	8.1*	9.6*	10.2
	5 ft lb					34.6*	38.5*	25.6*	30.4*	20.3*	24.9*	17.9*	21.1*	33'5"
	0 m t					16.1*	17.7*	11.9*	14.0*	9.4*	11.5*	8.4*	10.2*	9.9
	0 ft lb					34.6*	38.5*	25.6*	30.4*	20.3*	24.9*	18.4*	22.5*	32'7"
	-1.5 m t			14.5*	14.5*	16.2*	16.9*	11.9*	13.6*	9.4*	11.0*	9.0*	10.3*	9.5
	-5 ft lb			34.4*	34.4*	34.8*	36.6*	25.6*	29.4*	20.4*	23.7*	19.8*	22.6*	31'
	-3.0 m t			18.2*	18.2*	15.3*	15.3*	12.1*	12.4*			10.1*	10.1*	8.7
	-10 ft lb			39.8*	39.8*	33.2*	33.2*	26.1*	26.7*			22.3*	22.3*	28'5"
-4.5 m t			15.0*	15.0*	12.5*	12.5*					9.6*	9.6*	7.5	
-15 ft lb			32.5*	32.5*	26.9*	26.9*					20.9*	20.9*	24'4"	
-6.0 m t														
-20 ft lb														

Stick 2.90 m / 9'6"

Under-carriage	Height	3.0 m / 10 ft		4.5 m / 15 ft		6.0 m / 20 ft		7.5 m / 25 ft		9.0 m / 30 ft		10.5 m / 35 ft		m		
		Can be slewed through 360°	In longitudinal position of undercarriage	Can be slewed through 360°	In longitudinal position of undercarriage	Can be slewed through 360°	In longitudinal position of undercarriage	Can be slewed through 360°	In longitudinal position of undercarriage	Can be slewed through 360°	In longitudinal position of undercarriage	Can be slewed through 360°	In longitudinal position of undercarriage			
LC-V	10.5 m t												8.6*	8.6*		
	35 ft lb															
	9.0 m t								9.6*	9.6*			7.5*	7.5*	8.2	
	30 ft lb								21.3*	21.3*			16.7*	16.7*	26'7"	
	7.5 m t								9.8*	9.8*	9.3*	9.3*	7.1*	7.1*	9.3	
	25 ft lb								21.4*	21.4*	20.3*	20.3*	15.6*	15.6*	30'4"	
	6.0 m t						12.5*	12.5*	10.6*	10.6*	9.6*	9.6*	6.9*	6.9*	10.0	
	20 ft lb								27.0*	27.0*	23.0*	23.0*	15.1*	15.1*	32'10"	
	4.5 m t								16.7*	16.7*	12.6*	12.8*	9.8*	10.7*	10.7	
	15 ft lb								31.6*	31.6*	25.3*	25.3*	21.9*	21.9*	34'5"	
HD	3.0 m t								16.7*	16.7*	12.6*	12.8*	9.8*	10.7*	10.7	
	10 ft lb								36.0*	36.0*	27.2*	27.7*	21.2*	23.2*	35'1"	
	1.5 m t								16.2*	17.8*	12.1*	13.6*	9.5*	11.2*	10.7	
	5 ft lb								35.1*	38.4*	26.2*	29.4*	20.5*	24.2*	35'1"	
	0 m t								16.0*	17.9*	11.8*	13.9*	9.3*	11.4*	10.5	
	0 ft lb								34.5*	38.7*	25.5*	30.2*	20.1*	24.6*	34'5"	
	-1.5 m t					15.7*	15.7*	16.0*	17.3*	11.7*	13.7*	9.3*	11.1*	8.2*	9.0*	10.0
	-5 ft lb					36.3*	36.3*	34.5*	37.5*	25.4*	29.7*	20.0*	24.1*	18.1*	19.8*	32'10"
	-3.0 m t			17.8*	17.8*	19.9*	19.9*	16.0*	16.0*	11.9*	12.8*	9.4*	10.1*	9.2*	9.6*	9.3
	-10 ft lb			40.2*	40.2*	43.2*	43.2*	34.6*	34.6*	25.6*	27.7*	20.5*	21.4*	20.4*	21.2*	30'5"
-4.5 m t			20.2*	20.2*	16.9*	16.9*	13.7*	13.7*	10.7*	10.7*			9.3*	9.3*	8.2	
-15 ft lb			43.8*	43.8*	36.5*	36.5*	29.5*	29.5*	22.7*	22.7*			20.5*	20.5*	26'8"	
-6.0 m t									9.2*	9.2*			8.1*	8.1*	6.6	
-20 ft lb													19.6*	19.6*	21'1"	

Height Can be slewed through 360° In longitudinal position of undercarriage Max. reach * Limited by hydr. capacity

The load values are quoted in tons (t) / lb x 1,000 at stick end (without bucket), and may be swung 360° on firm and even ground. Adjacent values are valid for the undercarriage when in the longitudinal position. Capacities are valid for 750 mm/30" wide track pads. Indicated loads are based on ISO 10567 standard and do not exceed 75% of tipping or 87% of hydraulic capacity (indicated via *). Without bucket cylinder, link and lever the lift capacities will increase by 825 kg / 1,820 lb. Lifting capacity of the excavator is limited by machine stability and hydraulic capacity.

Stick 3.80 m / 12'6"

Under-carriage	3.0 m 10 ft		4.5 m 15 ft		6.0 m 20 ft		7.5 m 25 ft		9.0 m 30 ft		10.5 m 35 ft		m ft in			
	t	lb	t	lb	t	lb	t	lb	t	lb	t	lb	m	ft	in	
LC-V	10.5 m												5.8*	5.8*	8.0	
	35 ft												13,0*	13,0*	25'6"	
	9.0 m								7.9*	7.9*			5.2*	5.2*	9.3	
	30 ft								14,6*	14,6*			11,6*	11,6*	30'4"	
	7.5 m								8.3*	8.3*			4.9*	4.9*	10.3	
	25 ft								18,2*	18,2*			10,9*	10,9*	33'7"	
	6.0 m						9.5*	9.5*	8.7*	8.7*	8.3*	8.3*	4.8*	4.8*	11.0	
	20 ft						20,7*	20,7*	19,0*	19,0*	16,0*	16,0*	10,6*	10,6*	35'10"	
	4.5 m		18.5*	18.5*	13.2*	13.2*	10.7*	10.7*	9.3*	9.3*	8.1*	8.5*	4.8*	4.8*	11.4	
	15 ft		39,3*	39,3*	28,4*	28,4*	23,2*	23,2*	20,3*	20,3*	17,5*	18,6*	10,6*	10,6*	37'4"	
	3.0 m				15.4*	15.4*	12.0*	12.0*	9.9*	10.1*	7.9*	8.9*	4.9*	4.9*	11.6	
	10 ft				33,2*	33,2*	25,9*	25,9*	21,5*	21,9*	17,0*	19,4*	10,8*	10,8*	38'	
1.5 m				16.6*	17.1*	12.3*	13.0*	9.6*	10.7*	7.7*	9.2*	5.2*	5.2*	11.6		
5 ft				35,8*	36,8*	26,5*	28,2*	20,7*	23,2*	16,6*	20,1*	11,3*	11,3*	38'		
0 m			9.9*	9.9*	16.1*	17.8*	11.9*	13.7*	9.3*	11.1*	7.5*	9.4*	5.5*	5.5*	11.4	
0 ft			23,0*	23,0*	34,6*	38,5*	25,6*	29,6*	20,1*	24,1*	16,3*	20,4*	12,2*	12,2*	37'4"	
-1.5 m	8.7*	8.7*	15.3*	15.3*	15.9*	17.7*	11.7*	13.8*	9.2*	11.2*	7.5*	9.3*	6.1*	6.1*	10.9	
-5 ft	19,6*	19,6*	35,0*	35,0*	34,2*	38,3*	25,2*	29,9*	19,8*	24,3*	16,2*	20,0*	13,5*	13,5*	35'11"	
-3.0 m	14.9*	14.9*	22.0*	22.0*	15.9*	16.9*	11.7*	13.3*	9.2*	10.8*			7.1*	7.1*	10.3	
-10 ft	33,5*	33,5*	47,7*	47,7*	34,4*	36,5*	25,2*	28,8*	19,8*	23,2*			15,7*	15,7*	33'7"	
-4.5 m	21.9*	21.9*	19.5*	19.5*	15.2*	15.2*	11.9*	12.1*	9.3*	9.3*			8.8*	8.8*	9.3	
-15 ft	49,7*	49,7*	42,1*	42,1*	32,8*	32,8*	25,6*	25,9*	19,3*	19,3*			19,3*	19,3*	30'4"	
-6.0 m	20.0*	20.0*	15.6*	15.6*	12.2*	12.2*	9.1*	9.1*					8.3*	8.3*	7.9	
-20 ft			33,2*	33,2*	26,0*	26,0*	18,5*	18,5*					18,2*	18,2*	25'7"	
HD	10.5 m												5.9*	5.9*	8.0	
	35 ft												13,2*	13,2*	25'6"	
	9.0 m								7.5*	7.5*			5.3*	5.3*	9.3	
	30 ft								13,5*	13,5*			11,7*	11,7*	30'4"	
	7.5 m								8.3*	8.3*			5.0*	5.0*	10.3	
	25 ft								18,2*	18,2*			11,0*	11,0*	33'7"	
	6.0 m						9.5*	9.5*	8.7*	8.7*	8.0*	8.2*	4.8*	4.8*	11.0	
	20 ft						20,6*	20,6*	18,9*	18,9*	15,5*	15,5*	10,6*	10,6*	35'10"	
	4.5 m			18.1*	18.1*	13.0*	13.0*	10.6*	10.6*	9.3*	9.3*	7.8*	8.5*	4.8*	4.8*	11.4
	15 ft			38,6*	38,6*	28,0*	28,0*	23,0*	23,0*	20,2*	20,2*	16,8*	18,6*	10,6*	10,6*	37'4"
	3.0 m					15.3*	15.3*	11.9*	11.9*	9.6*	10.0*	7.6*	8.9*	4.9*	4.9*	11.6
	10 ft					32,9*	32,9*	25,7*	25,7*	20,7*	21,8*	16,4*	19,3*	10,8*	10,8*	38'
1.5 m					16.0*	17.0*	11.8*	13.0*	9.2*	10.7*	7.4*	9.2*	5.1*	5.1*	11.6	
5 ft					34,4*	36,6*	25,5*	28,1*	19,8*	23,2*	15,9*	20,1*	11,3*	11,3*	38'	
0 m			9.6*	9.6*	15.4*	17.8*	11.4*	13.6*	8.9*	11.1*	7.2*	9.4*	5.5*	5.5*	11.4	
0 ft			22,3*	22,3*	33,3*	38,4*	24,6*	29,5*	19,2*	24,1*	15,6*	20,4*	12,1*	12,1*	37'4"	
-1.5 m	8.2*	8.2*	14.9*	14.9*	15.2*	17.7*	11.2*	13.8*	8.8*	11.2*	7.2*	9.3*	6.1*	6.1*	10.9	
-5 ft	18,6*	18,6*	34,1*	34,1*	32,8*	38,4*	24,1*	29,9*	18,9*	24,3*	15,5*	20,0*	13,4*	13,4*	35'11"	
-3.0 m	14.4*	14.4*	21.7*	21.7*	15.3*	17.0*	11.2*	13.4*	8.8*	10.8*			7.0*	7.0*	10.3	
-10 ft	32,6*	32,6*	48,0*	48,0*	32,9*	36,7*	24,1*	28,9*	18,9*	23,3*			15,5*	15,5*	33'7"	
-4.5 m	21.4*	21.4*	19.7*	19.7*	15.4*	15.4*	11.3*	12.2*	9.0*	9.4*			8.6*	8.6*	9.3	
-15 ft	48,4*	48,4*	42,6*	42,6*	33,2*	33,2*	24,5*	26,2*	19,5*	19,8*			19,3*	19,3*	30'4"	
-6.0 m	20.5*	20.5*	15.9*	15.9*	12.5*	12.5*	9.4*	9.4*					8.4*	8.4*	7.9	
-20 ft			43,7*	43,7*	33,9*	33,9*	26,6*	26,6*	19,4*	19,4*			18,3*	18,3*	25'7"	

Height
 Can be slewed through 360°
 In longitudinal position of undercarriage
 Max. reach
 * Limited by hydr. capacity

The load values are quoted in tons (t) / lb x 1,000 at stick end (without bucket), and may be swung 360° on firm and even ground. Adjacent values are valid for the undercarriage when in the longitudinal position. Capacities are valid for 750 mm / 30" wide track pads. Indicated loads are based on ISO 10567 standard and do not exceed 75% of tipping or 87% of hydraulic capacity (indicated via *). Without bucket cylinder, link and lever the lift capacities will increase by 825 kg / 1,820 lb. Lifting capacity of the excavator is limited by machine stability and hydraulic capacity.

Lift Capacities

with Mono Boom Straight 8.00 m / 26'3", Counterweight 11.0 t / 24,250 lb and Track Pads 750 mm / 30"

Stick 2.35 m / 7'9"

Under-carriage	4.5 m 15 ft	6.0 m 20 ft	7.5 m 25 ft	9.0 m 30 ft	10.5 m 35 ft	12.0 m 40 ft	m	
							ft	in
12.0 m t								
40 ft lb								
10.5 m t		15.0*	15.0*			11.9*	11.9*	6.6
35 ft lb		33.2*	33.2*			27.0*	27.0*	20'11"
9.0 m t		14.7*	14.7*	12.8*	12.8*	10.2*	10.2*	8.2
30 ft lb		32.1*	32.1*	27.8	28.0*	22.7*	22.7*	26'6"
7.5 m t	20.0*	20.0*	15.4*	15.4*	12.7	12.9*	9.4	11.3*
25 ft lb	42.9*	42.9*	33.4*	33.4*	27.4	28.0*	20.2	24.8*
6.0 m t		16.7*	16.7*	12.2	13.4*	9.3	11.4*	
20 ft lb		35.9*	35.9*	26.3	29.0*	19.9	24.7*	
4.5 m t			11.5	13.9*	8.9	11.5*		
15 ft lb			33.4	38.7*	24.9	30.1*	19.3	25.0*
3.0 m t			10.9	14.1*	8.6	11.6*	6.9	9.6*
10 ft lb			23.6	30.6*	18.6	25.1*	15.0	20.5*
1.5 m t			10.6	13.8*	8.4	11.3*	6.8	9.2*
5 ft lb			22.8	30.0*	18.1	24.5*	14.8	19.5*
0 m t			10.4	12.9*	8.2	10.6*	6.9	8.2*
0 ft lb			22.5	27.9*	17.8	22.9*	15.2	18.0*
-1.5 m t			12.5*	12.5*	10.5	11.3*	8.3	9.3*
-5 ft lb			27.5*	27.5*	22.6	24.5*	17.9	19.9*
-3.0 m t			9.9*	9.9*	9.0*	9.0*	6.7*	6.7*
-10 ft lb			21.5*	21.5*	19.3*	19.3*	13.5*	13.5*
-4.5 m t								
-15 ft lb								

Stick 2.90 m / 9'6"

Under-carriage	4.5 m 15 ft	6.0 m 20 ft	7.5 m 25 ft	9.0 m 30 ft	10.5 m 35 ft	12.0 m 40 ft	m	
							ft	in
12.0 m t								
40 ft lb								
10.5 m t		14.0*	14.0*			11.9*	11.9*	6.6
35 ft lb		30.8*	30.8*			27.0*	27.0*	20'11"
9.0 m t		14.0*	14.0*	12.1*	12.1*	10.2*	10.2*	8.2
30 ft lb		30.4*	30.4*	26.5*	26.5*	22.7*	22.7*	26'6"
7.5 m t	15.3*	15.3*	14.7*	14.7*	12.4*	12.4*	9.6	10.9*
25 ft lb	32.7*	32.7*	31.8*	31.8*	26.9*	26.9*	20.5	23.7*
6.0 m t		16.0*	16.0*	12.3	12.9*	9.3	11.0*	
20 ft lb		34.5*	34.5*	26.6	28.0*	20.1	24.0*	
4.5 m t		15.8	17.4*	11.6	13.6*	9.0	11.3*	7.1
15 ft lb		34.3	37.5*	25.2	29.4*	19.3	24.5*	15.2
3.0 m t			11.0	14.0*	8.6	11.4*	6.9	9.6*
10 ft lb			23.8	30.3*	18.6	24.8*	14.9	20.8*
1.5 m t			10.6	13.9*	8.3	11.3*	6.8	9.4*
5 ft lb			22.8	28.1*	18.0	24.5*	14.6	20.1*
0 m t			14.1	15.4*	10.4	13.2*	8.2	10.8*
0 ft lb			30.4	34.5*	22.4	28.6*	17.6	23.4*
-1.5 m t			13.8*	13.8*	10.3	11.9*	8.1	9.7*
-5 ft lb			30.2*	30.2*	22.3	25.7*	17.6	20.9*
-3.0 m t			11.2*	11.2*	9.8*	9.8*	7.8*	7.8*
-10 ft lb			24.5*	24.5*	21.2*	21.2*	16.5*	16.5*
-4.5 m t			7.8*	7.8*	6.7*	6.7*		
-15 ft lb								

Stick 3.80 m / 12'6"

Under-carriage	4.5 m 15 ft	6.0 m 20 ft	7.5 m 25 ft	9.0 m 30 ft	10.5 m 35 ft	12.0 m 40 ft	m	
							ft	in
12.0 m t								
40 ft lb								
10.5 m t			10.3*	10.3*			7.3*	7.3*
35 ft lb			22.2*	22.2*			16.7*	16.7*
9.0 m t			10.6*	10.6*	9.8*	9.8*	6.0*	6.0*
30 ft lb			23.4*	23.4*	20.7*	20.7*	13.5*	13.5*
7.5 m t		10.6*	10.6*	11.2*	11.2*	9.8	10.2*	7.5
25 ft lb		23.3*	23.3*	24.6*	24.6*	21.1	22.2*	15.0*
6.0 m t	18.0*	18.0*	14.7*	14.7*	12.2*	12.2*	9.5	10.5*
20 ft lb	35.3*	35.3*	31.1*	31.1*	26.4*	26.4*	20.5	22.8*
4.5 m t		16.4*	16.4*	12.0	13.0*	9.1	10.9*	7.2
15 ft lb		35.5*	35.5*	25.8	28.1*	19.7	23.6*	15.4
3.0 m t		15.3	17.7*	11.3	13.6*	8.7	11.2*	6.9
10 ft lb		33.0	38.2*	24.3	29.5*	18.8	24.3*	14.9
1.5 m t		14.4	17.9*	10.7	13.9*	8.4	11.3*	6.7
5 ft lb		31.1	38.7*	23.1	30.1*	18.0	24.5*	14.5
0 m t		14.1	17.0*	10.4	13.6*	8.1	11.0*	6.6
0 ft lb		30.3	37.0*	22.4	29.4*	17.5	23.9*	14.2
-1.5 m t	9.9*	9.9*	14.0	15.5*	10.2	12.7*	8.0	10.3*
-5 ft lb	22.9*	22.9*	30.2	33.6*	22.1	27.4*	17.3	22.3*
-3.0 m t	14.8*	14.8*	13.2*	13.2*	10.3	11.1*	8.0	9.0*
-10 ft lb	32.3*	32.3*	28.7*	28.7*	22.2	23.9*	17.4	19.2*
-4.5 m t	10.9*	10.9*	10.2*	10.2*	8.6*	8.6*	6.6*	6.6*
-15 ft lb	23.6*	23.6*	21.9*	21.9*	18.4*	18.4*	13.8*	13.8*

Height
 Can be slewed through 360°
 In longitudinal position of undercarriage
 Max. reach
 * Limited by hydr. capacity

The load values are quoted in tons (t) / lb x 1,000 at stick end (without bucket), and may be swung 360° on firm and even ground. Adjacent values are valid for the undercarriage when in the longitudinal position. Capacities are valid for 750 mm / 30" wide track pads. Indicated loads are based on ISO 10567 standard and do not exceed 75% of tipping or 87% of hydraulic capacity (indicated via *). Without bucket cylinder, link and lever the lift capacities will increase by 825 kg / 1,820 lb. Lifting capacity of the excavator is limited by machine stability and hydraulic capacity.

Lift Capacities

with Mono Boom Straight 8.00 m / 26'3", Removable Counterweight 12.0 t / 26,460 lb and Track Pads 750 mm / 30"

Stick 2.35 m / 7'9"

Under-carriage	4.5 m 15 ft	6.0 m 20 ft	7.5 m 25 ft	9.0 m 30 ft	10.5 m 35 ft	12.0 m 40 ft	m	
							ft	in
12.0 m t								
40 ft lb								
10.5 m t		15.0*	15.0*			11.9*	11.9*	6.6
35 ft lb		33.2*	33.2*			27.0*	27.0*	20'10"
9.0 m t		14.7*	14.7*	12.8*	12.8*	10.2*	10.2*	8.2
30 ft lb		32.1*	32.1*	28.0*	28.0*	22.7*	22.7*	26'6"
7.5 m t	20.0*	20.0*	15.4*	15.4*	12.9*	12.9*	10.0	11.3*
25 ft lb	42.9*	42.9*	33.4*	33.4*	28.0*	28.0*	21.4	24.8*
6.0 m t		16.7*	16.7*	12.9	13.4*	9.8	11.4*	
20 ft lb		35.9*	35.9*	27.8	29.0*	21.1	24.7*	
4.5 m t			12.2	13.9*	9.5	11.5*		
15 ft lb			35.3	38.7*	26.4	30.1*	20.5	25.0*
3.0 m t			11.6	14.1*	9.1	11.6*	7.4	9.6*
10 ft lb			25.1	30.6*	19.8	25.1*	16.0	20.5*
1.5 m t			11.3	13.8*	8.9	11.3*	7.3	9.2*
5 ft lb			24.3	30.0*	19.2	24.5*	15.8	19.5*
0 m t			11.1	12.9*	8.8	10.6*	7.4	8.2*
0 ft lb			29.4*	29.4*	24.0	27.9*	19.0	22.9*
-1.5 m t			12.5*	12.5*	11.2	11.3*	8.8	9.3*
-5 ft lb			27.5*	27.5*	24.1	24.5*	19.1	19.9*
-3.0 m t			9.9*	9.9*	9.0*	9.0*	6.7*	6.7*
-10 ft lb			21.5*	21.5*	19.3*	19.3*	13.5*	13.5*
-4.5 m t								
-15 ft lb								

Stick 2.90 m / 9'6"

Under-carriage	4.5 m 15 ft	6.0 m 20 ft	7.5 m 25 ft	9.0 m 30 ft	10.5 m 35 ft	12.0 m 40 ft	m	
							ft	in
12.0 m t								
40 ft lb								
10.5 m t		14.0*	14.0*			11.9*	11.9*	6.6
35 ft lb		30.8*	30.8*			27.0*	27.0*	20'10"
9.0 m t		14.0*	14.0*	12.1*	12.1*	10.2*	10.2*	8.2
30 ft lb		30.4*	30.4*	26.5*	26.5*	22.7*	22.7*	26'6"
7.5 m t	15.3*	15.3*	14.7*	14.7*	12.4*	12.4*	10.1	10.9*
25 ft lb	32.7*	32.7*	31.8*	31.8*	26.9*	26.9*	21.7	23.7*
6.0 m t		16.0*	16.0*	12.9*	12.9*	9.9	11.0*	7.7
20 ft lb		34.5*	34.5*	28.0*	28.0*	21.3	24.0*	
4.5 m t		16.7	17.4*	12.3	13.6*	9.5	11.3*	7.5
15 ft lb		36.2	37.5*	26.7	29.4*	20.5	24.5*	16.2
3.0 m t			11.7	14.0*	9.1	11.4*	7.4	9.6*
10 ft lb			33.8	37.7*	25.3	30.3*	19.8	24.8*
1.5 m t			11.3	13.9*	8.9	11.3*	7.2	9.4*
5 ft lb			28.1*	28.1*	24.3	30.1*	19.1	24.5*
0 m t			15.0	15.4*	11.0	13.2*	8.7	10.8*
0 ft lb			32.4	34.5*	23.9	28.6*	18.8	23.4*
-1.5 m t			13.8*	13.8*	11.0	11.9*	8.7	9.7*
-5 ft lb			30.2*	30.2*	23.8	25.7*	18.8	20.9*
-3.0 m t			11.2*	11.2*	9.8*	9.8*	7.8*	7.8*
-10 ft lb			24.5*	24.5*	21.2*	21.2*	16.5*	16.5*
-4.5 m t			7.8*	7.8*	6.7*	6.7*		
-15 ft lb								

Stick 3.80 m / 12'6"

Under-carriage	4.5 m 15 ft	6.0 m 20 ft	7.5 m 25 ft	9.0 m 30 ft	10.5 m 35 ft	12.0 m 40 ft	m	
							ft	in
12.0 m t								
40 ft lb								
10.5 m t			10.3*	10.3*			7.3*	7.3*
35 ft lb			22.2*	22.2*			16.7*	16.7*
9.0 m t			10.6*	10.6*	9.8*	9.8*	5.4*	5.4*
30 ft lb			23.4*	23.4*	20.7*	20.7*	12.0*	12.0*
7.5 m t		10.6*	10.6*	11.2*	11.2*	10.2*	10.2*	7.9
25 ft lb		23.3*	23.3*	24.6*	24.6*	22.2*	22.2*	15.0*
6.0 m t	18.0*	18.0*	14.7*	14.7*	12.2*	12.2*	10.1	10.5*
20 ft lb	35.3*	35.3*	31.1*	31.1*	26.4*	26.4*	21.7	22.8*
4.5 m t		16.4*	16.4*	12.7	13.0*	9.7	10.9*	7.6
15 ft lb		35.5*	35.5*	27.3	28.1*	20.8	23.6*	16.4
3.0 m t		16.2	17.7*	12.0	13.6*	9.3	11.2*	7.4
10 ft lb		35.0	38.2*	25.8	29.5*	20.0	24.3*	15.9
1.5 m t		15.3	17.9*	11.4	13.9*	8.9	11.3*	7.2
5 ft lb		33.1	38.7*	24.6	30.1*	19.2	24.5*	15.5
0 m t		15.0	17.0*	11.1	13.6*	8.7	11.0*	7.0
0 ft lb		32.3	37.0*	23.9	29.4*	18.7	23.9*	15.2
-1.5 m t	9.9*	9.9*	14.9	15.5*	10.9	12.7*	8.6	10.3*
-5 ft lb	22.9*	22.9*	32.2	33.6*	23.6	27.4*	18.5	22.3*
-3.0 m t	14.8*	14.8*	13.2*	13.2*	11.0	11.1*	8.6	9.0*
-10 ft lb	32.3*	32.3*	28.7*	28.7*	23.7	23.9*	18.6	19.2*
-4.5 m t	10.9*	10.9*	10.2*	10.2*	8.6*	8.6*	6.6*	6.6*
-15 ft lb	23.6*	23.6*	21.9*	21.9*	18.4*	18.4*	13.8*	13.8*

 Height
  Can be slewed through 360°
  In longitudinal position of undercarriage
  Max. reach
 * Limited by hydr. capacity

The load values are quoted in tons (t) / lb x 1,000 at stick end (without bucket), and may be swung 360° on firm and even ground. Adjacent values are valid for the undercarriage when in the longitudinal position. Capacities are valid for 750 mm / 30" wide track pads. Indicated loads are based on ISO 10567 standard and do not exceed 75% of tipping or 87% of hydraulic capacity (indicated via *). Without bucket cylinder, link and lever the lift capacities will increase by 825 kg / 1,820 lb. Lifting capacity of the excavator is limited by machine stability and hydraulic capacity.

Lift Capacities

with Mono Boom 9.20 m/30'2", Counterweight 11.0 t/24,250 lb and Track Pads 750 mm/30"

Stick 2.90 m / 9'6"

Under-carriage	3.0 m 10 ft	4.5 m 15 ft	6.0 m 20 ft	7.5 m 25 ft	9.0 m 30 ft	10.5 m 35 ft	12.0 m 40 ft	13.5 m 45 ft	m ft in					
									LC-V	LC-V	LC-V			
12.0 m t														
40 ft lb														
10.5 m t						7.5*	7.5*				7.6*	7.6*	9.1	
35 ft lb											16,8*	16,8*	29'	
9.0 m t											7.3*	7.3*	10.3	
30 ft lb											16,1*	16,1*	33'6"	
7.5 m t					8.7*	8.7*		7.2*	7.2*		6.8	7.0*	11.2	
25 ft lb					18,7*	18,7*	16,8*	16,8*	15,8*	15,8*	15,1	15,4*	36'5"	
6.0 m t					9.8*	9.8*	8.3*	8.3*	7.5	7.5*	6.1	6.8*	11.8	
20 ft lb			27,3*	27,3*	21,1*	21,1*	18,0*	18,0*	16,1	16,3*	13,5	15,1*	38'6"	
4.5 m t					11.1*	11.1*	8.9	9.0*	7.2	7.9*	5.8	7.2*	12.2	
15 ft lb					23,8*	23,8*	19,3	19,5*	15,5	17,1*	12,5	15,1*	39'11"	
3.0 m t					10.7	12.2*	8.5	9.7*	6.9	8.3*	5.7	7.4*	12.4	
10 ft lb					23,0	26,1*	18,3	20,9*	14,9	17,9*	12,2	16,2*	40'6"	
1.5 m t					10.3	12.8*	8.2	10.2*	6.7	8.6*	5.6	7.6*	12.3	
5 ft lb					22,1	27,5*	17,6	22,0*	14,4	18,7*	11,9	16,5*	40'6"	
0 m t					10.1	12.9*	8.0	10.5*	6.5	8.8*	5.5	7.6*	12.2	
0 ft lb					21,8	28,0*	17,2	22,6*	14,1	19,1*	11,9	16,6*	39'11"	
-1.5 m t			10.6*	10.6*	10.1	12.7*	7.9	10.5*	6.5	8.8*	5.7	7.6*	11.8	
-5 ft lb			25,9*	25,9*	21,7	27,6*	17,0	22,6*	14,0	19,0*	12,5	16,8*	38'7"	
-3.0 m t		10.4*	10.4*	14.3	14.7*	10.2	12.2*	8.0	10.2*	6.6	8.4*	6.2	7.7*	11.1
-10 ft lb		24,7*	24,7*	30,6	31,9*	22,0	26,5*	17,2	21,9*	14,2	18,1*	13,7	17,0*	36'6"
-4.5 m t		15.6*	15.6*	13.5*	13.5*	10.5	11.3*	8.2	9.4*		7.1	7.7*	10.3	
-15 ft lb		34,0*	34,0*	29,3*	29,3*	22,5	24,4*	17,7	20,1*		15,8	17,0*	33'6"	
-6.0 m t		13.6*	13.6*	11.7*	11.7*	9.7*	9.7*				7.5*	7.5*	9.0	
-20 ft lb		29,3*	29,3*	25,0*	25,0*	20,7*	20,7*				16,4*	16,4*	29'5"	
-7.5 m t			8.4*	8.4*							6.6*	6.6*	7.3	
-25 ft lb														
-9.0 m t														
-30 ft lb														



















Stick 3.80 m / 12'6"

Under-carriage	3.0 m 10 ft	4.5 m 15 ft	6.0 m 20 ft	7.5 m 25 ft	9.0 m 30 ft	10.5 m 35 ft	12.0 m 40 ft	13.5 m 45 ft	m ft in				
									LC-V	LC-V	LC-V		
12.0 m t											6.0*	6.0*	
40 ft lb													
10.5 m t											5.4*	5.4*	10.2
35 ft lb											12,1*	12,1*	33'1"
9.0 m t											5.1*	5.1*	11.3
30 ft lb											11,3*	11,3*	36'11"
7.5 m t						7.0*	7.0*	6.5*	6.5*	6.1	6.4*		12.1
25 ft lb						15,2*	15,2*	14,3*	14,3*				39'7"
6.0 m t						7.6*	7.6*	6.9*	6.9*	6.1	6.5*		12.7
20 ft lb			11,2*	11,2*	8,9*	8,9*	16,5*	16,5*	15,0*	15,0*	12,9	14,2*	41'6"
4.5 m t					10.2*	10.2*	8.4*	8.4*	7.3	7.4*	5.9	6.7*	13.0
15 ft lb			29,2*	29,2*	21,9*	21,9*	18,1*	18,1*	15,7	15,9*	12,6	14,6*	42'8"
3.0 m t					11.0	11.4*	8.6	9.2*	7.0	7.8*	5.7	7.0*	13.2
10 ft lb					23,7	24,5*	18,6	19,8*	15,0	17,0*	12,2	15,2*	43'5"
1.5 m t					10.4	12.3*	8.2	9.8*	6.7	8.3*	5.5	7.3*	13.2
5 ft lb					22,5	26,5*	17,7	21,2*	14,4	17,9*	11,9	15,7*	43'5"
0 m t					10.1	12.7*	8.0	10.2*	6.5	8.6*	5.4	7.4*	13.0
0 ft lb			7,8*	7,8*	21,8	27,5*	17,1	22,1*	14,0	18,5*	11,6	16,1*	42'10"
-1.5 m t			12.6*	12.6*	10.0	12.8*	7.8	10.4*	6.4	8.7*	5.3	7.4*	12.7
-5 ft lb			29,4*	29,4*	21,5	27,7*	16,8	22,5*	13,7	18,8*	11,5	16,1*	41'6"
-3.0 m t		11.0*	11.0*	13.9	15.6*	10.0	12.5*	7.8	10.3*	6.4	8.6*	5.4	7.1*
-10 ft lb	16,7*	16,7*	25,2*	25,2*	29,9	33,7*	21,6	27,1*	16,8	22,2*	13,7	18,5*	39'7"
-4.5 m t	13.4*	13.4*	17.4*	17.4*	14.2	14.6*	10.2	11.9*	7.9	9.8*	6.5	8.0*	11.3
-15 ft lb	30,3*	30,3*	39,1*	39,1*	30,4	31,5*	21,9	25,6*	17,1	21,1*	14,1	17,2*	36'11"
-6.0 m t	19.6*	19.6*	16.0*	16.0*	13.1*	13.1*	10.5	10.7*	8.2	8.7*			10.2
-20 ft lb	43,3*	43,3*	34,5*	34,5*	28,1*	28,1*	22,6	22,9*	17,7	18,5*			33'2"
-7.5 m t		12.9*	12.9*	10.6*	10.6*	8.5*	8.5*				6.7*	6.7*	8.7
-25 ft lb		27,4*	27,4*	22,5*	22,5*	17,8*	17,8*				14,7*	14,7*	28'1"
-9.0 m t													
-30 ft lb													

Height
 Can be slewed through 360°
 In longitudinal position of undercarriage
 Max. reach
 * Limited by hydr. capacity

The load values are quoted in tons (t) / lb x 1,000 at stick end (without bucket), and may be swung 360° on firm and even ground. Adjacent values are valid for the undercarriage when in the longitudinal position. Capacities are valid for 750 mm/30" wide track pads. Indicated loads are based on ISO 10567 standard and do not exceed 75% of tipping or 87% of hydraulic capacity (indicated via *). Without bucket cylinder, link and lever the lift capacities will increase by 825 kg/1,820 lb. Lifting capacity of the excavator is limited by machine stability and hydraulic capacity.

Stick 5.00 m / 16'5"

Under-carriage	3.0 m 10 ft		4.5 m 15 ft		6.0 m 20 ft		7.5 m 25 ft		9.0 m 30 ft		10.5 m 35 ft		12.0 m 40 ft		13.5 m 45 ft		m ft in			
																				
12.0 m t																		4.1*	4.1*	10.4
40 ft lb																		9.1*	9.1*	33'5"
10.5 m t																		3.8*	3.8*	11.6
35 ft lb																		8.4*	8.4*	37'10"
9.0 m t																		3.6*	3.6*	12.6
30 ft lb																		7.9*	7.9*	41'1"
7.5 m t																		3.5*	3.5*	13.3
25 ft lb																		7.7*	7.7*	43'6"
6.0 m t																		3.4*	3.4*	13.8
20 ft lb																		7.6*	7.6*	45'4"
4.5 m t																		3.5*	3.5*	14.2
15 ft lb																		7.6*	7.6*	46'5"
3.0 m t																		3.5*	3.5*	14.3
10 ft lb																		7.8*	7.8*	47'
1.5 m t																		3.7*	3.7*	14.3
5 ft lb																		8.1*	8.1*	47'
0 m t																		3.9*	3.9*	14.1
0 ft lb																		8.6*	8.6*	46'5"
-1.5 m t																		4.2*	4.2*	13.8
-5 ft lb																		9.2*	9.2*	45'4"
-3.0 m t																		4.6*	4.6*	13.3
-10 ft lb																		10.2*	10.2*	43'6"
-4.5 m t																		5.2*	5.2*	12.6
-15 ft lb																		11.6*	11.6*	41'1"
-6.0 m t																		6.0*	6.2*	11.6
-20 ft lb																		13.4*	13.9*	37'10"
-7.5 m t																		6.9*	6.9*	10.3
-25 ft lb																		15.1*	15.1*	33'5"
-9.0 m t																		6.5*	6.5*	8.6
-30 ft lb																		14.2*	14.2*	27'5"

 Height  Can be slewed through 360°  In longitudinal position of undercarriage  Max. reach * Limited by hydr. capacity

The load values are quoted in tons (t) / lb x 1,000 at stick end (without bucket), and may be swung 360° on firm and even ground. Adjacent values are valid for the undercarriage when in the longitudinal position. Capacities are valid for 750 mm / 30" wide track pads. Indicated loads are based on ISO 10567 standard and do not exceed 75% of tipping or 87% of hydraulic capacity (indicated via *). Without bucket cylinder, link and lever the lift capacities will increase by 825 kg, 1,820 lb / 620 kg* / 1,370 lb*. Lifting capacity of the excavator is limited by machine stability and hydraulic capacity.

* just for stick 5.00 m / 16'5"

Lift Capacities

with Mono Boom 9.20 m/30'2", Removable Counterweight 12.0 t/26,460 lb and Track Pads 750 mm/30"

Stick 2.90 m/9'6"

Under-carriage	3.0 m 10 ft	4.5 m 15 ft	6.0 m 20 ft	7.5 m 25 ft	9.0 m 30 ft	10.5 m 35 ft	12.0 m 40 ft	13.5 m 45 ft	m ft in					
									6.0	6.0	9.1			
12.0 m t														
40 ft lb														
10.5 m t						7.5*	7.5*				7.6*	7.6*	9.1	
35 ft lb											16,8*	16,8*	29'4"	
9.0 m t						7.4*	7.4*				7.3*	7.3*	10.3	
30 ft lb						16,2*	16,2*				16,1*	16,1*	33'6"	
7.5 m t				8.7*	8.7*	7.7*	7.7*	7.2*	7.2*		7.0*	7.0*	11.2	
25 ft lb				18,7*	18,7*	16,8*	16,8*	15,8*	15,8*		15,4*	15,4*	36'5"	
6.0 m t				9.8*	9.8*	8.3*	8.3*	7.5*	7.5*		6.5*	6.8*	11.8	
20 ft lb			27,4*	27,4*	21,1*	21,1*	18,0*	18,0*	16,3*	16,3*	14,4*	15,1*	38'6"	
4.5 m t				11.1*	11.1*	9.0*	9.0*	7.6*	7.9*	6.2	7.2*	6.0	6.9*	12.2
15 ft lb				23,8*	23,8*	19,5*	19,5*	16,5*	17,1*		13,4*	15,1*	39'11"	
3.0 m t				11.3	12.2*	9.0	9.7*	7.4	8.3*	6.1	7.4*	5.8	7.0*	12.4
10 ft lb				24,6	26,2*	19,6	21,0*	15,9	18,0*	13,1	16,2*	12,8	15,4*	40'6"
1.5 m t				10.9	12.8*	8.7	10.2*	7.1	8.6*	5.9	7.6*	5.7	7.3*	12.3
5 ft lb				23,7	27,6*	18,8	22,1*	15,4	18,7*	12,8	16,5*	12,6	16,0*	40'6"
0 m t				10.8	12.9*	8.5	10.5*	7.0	8.8*	5.9	7.6*	5.8	7.5*	12.2
0 ft lb				23,3	28,0*	18,4	22,7*	15,1	19,1*			12,8	16,6*	39'11"
-1.5 m t			10.6*	10.6*	10.8	12.7*	8.5	10.5*	6.9	8.8*		6.1	7.6*	11.8
-5 ft lb			25,9*	25,9*	23,3	27,6*	18,3	22,7*	15,0	19,0*		13,4	16,9*	38'7"
-3.0 m t		10.4*	10.4*	14.7*	14.7*	10.9	12.2*	8.5	10.2*	7.0	8.4*	6.6	7.7*	11.1
-10 ft lb		24,7*	24,7*	32,0*	32,0*	23,5	26,5*	18,4	22,0*	15,2	18,2*	14,7	17,1*	36'6"
-4.5 m t		15.6*	15.6*	13.5*	13.5*	11.1	11.3*	8.7	9.4*			7.6	7.7*	10.3
-15 ft lb		34,1*	34,1*	29,3*	29,3*	24,1	24,5*	18,9	20,1*			16,9	17,0*	33'6"
-6.0 m t		13.6*	13.6*	11.7*	11.7*	9.7*	9.7*					7.5*	7.5*	9.0
-20 ft lb		29,4*	29,4*	25,1*	25,1*	20,7*	20,7*					16,5*	16,5*	29'5"
-7.5 m t			8.4*	8.4*								6.6*	6.6*	7.3
-25 ft lb														23'4"
-9.0 m t														
-30 ft lb														

Stick 3.80 m/12'6"

Under-carriage	3.0 m 10 ft	4.5 m 15 ft	6.0 m 20 ft	7.5 m 25 ft	9.0 m 30 ft	10.5 m 35 ft	12.0 m 40 ft	13.5 m 45 ft	m ft in				
									6.0	6.0	10.2		
12.0 m t											6.0*	6.0*	
40 ft lb													
10.5 m t											5.4*	5.4*	10.2
35 ft lb											12,1*	12,1*	33'1"
9.0 m t											5.1*	5.1*	11.3
30 ft lb											11,3*	11,3*	36'11"
7.5 m t											4.9*	4.9*	12.1
25 ft lb											10,8*	10,8*	39'7"
6.0 m t											4.8*	4.8*	12.7
20 ft lb			11,2*	11,2*	8,9*	8,9*	15,2*	15,2*	14,3*	14,3*	13,8	14,2*	41'6"
4.5 m t			10.2*	10.2*	8.4*	8.4*	7.4*	7.4*	6.3	6.7*	10,6*	10,6*	42'8"
15 ft lb			29,3*	29,3*	21,9*	21,9*	18,2*	18,2*	16,0*	16,0*	13,5	14,6*	42'8"
3.0 m t											4.9*	4.9*	13.2
10 ft lb											10,8*	10,8*	43'5"
1.5 m t											5.1*	5.1*	13.2
5 ft lb											11,2*	11,2*	43'5"
0 m t											5.2	5.4*	13.0
0 ft lb			7,8*	7,8*	10,8	12,7*	8,5	10,2*	6,9	8,6*	12,5	16,1*	42'10"
-1.5 m t			12,6*	12,6*	10,7	12,8*	8,4	10,4*	6,8	8,7*	5,7	7,4*	12,7
-5 ft lb			29,4*	29,4*	23,1	27,7*	18,1	22,5*	14,8	18,8*	12,4	16,1*	41'6"
-3.0 m t											5.8	6.5*	12.1
-10 ft lb	16,7*	16,7*	11,0*	11,0*	14,8	15,6*	10,7	12,5*	8,4	10,3*	6,8	8,6*	12,1
-4.5 m t	13,4*	13,4*	17,4*	17,4*	14,6*	14,6*	10,9	11,9*	8,5	9,8*	7,0	8,0*	11,3
-15 ft lb	30,3*	30,3*	39,1*	39,1*	31,6*	31,6*	23,5	25,7*	18,3	21,1*	15,1	17,2*	36'11"
-6.0 m t											7.1*	7.1*	10.2
-20 ft lb	43,4*	43,4*	34,6*	34,6*	28,1*	28,1*	23,0*	23,0*	18,5*	18,5*			33'2"
-7.5 m t			12,9*	12,9*	10,6*	10,6*	8,5*	8,5*					8.7
-25 ft lb			27,4*	27,4*	22,5*	22,5*	17,8*	17,8*					28'1"
-9.0 m t													
-30 ft lb													

Height Can be slewed through 360° In longitudinal position of undercarriage Max. reach * Limited by hydr. capacity

The load values are quoted in tons (t) / lb x 1,000 at stick end (without bucket), and may be swung 360° on firm and even ground. Adjacent values are valid for the undercarriage when in the longitudinal position. Capacities are valid for 750 mm/30" wide track pads. Indicated loads are based on ISO 10567 standard and do not exceed 75% of tipping or 87% of hydraulic capacity (indicated via *). Without bucket cylinder, link and lever the lift capacities will increase by 825 kg/1,820 lb. Lifting capacity of the excavator is limited by machine stability and hydraulic capacity.

Stick 5.00 m / 16'5"

Under-carriage	3.0 m 10 ft		4.5 m 15 ft		6.0 m 20 ft		7.5 m 25 ft		9.0 m 30 ft		10.5 m 35 ft		12.0 m 40 ft		13.5 m 45 ft		m ft in		
12.0 m t																	4.1*	4.1*	10.4
40 ft lb																	9.1*	9.1*	33'5"
10.5 m t																	3.8*	3.8*	11.6
35 ft lb																	8.4*	8.4*	37'10"
9.0 m t																	3.6*	3.6*	12.6
30 ft lb																	7.9*	7.9*	41'1"
7.5 m t																	3.5*	3.5*	13.3
25 ft lb																	7.7*	7.7*	43'6"
6.0 m t																	3.4*	3.4*	13.8
20 ft lb																	7.6*	7.6*	45'4"
4.5 m t																	3.5*	3.5*	14.2
15 ft lb																	7.6*	7.6*	46'5"
3.0 m t																	3.5*	3.5*	14.3
10 ft lb																	7.8*	7.8*	47'
1.5 m t																	3.7*	3.7*	14.3
5 ft lb																	8.1*	8.1*	47'
0 m t																	3.9*	3.9*	14.1
0 ft lb																	8.6*	8.6*	46'5"
-1.5 m t																	4.2*	4.2*	13.8
-5 ft lb																	9.2*	9.2*	45'4"
-3.0 m t																	4.6*	4.6*	13.3
-10 ft lb																	10.2*	10.2*	43'6"
-4.5 m t																	5.2*	5.2*	12.6
-15 ft lb																	11.6*	11.6*	41'1"
-6.0 m t																	6.2*	6.2*	11.6
-20 ft lb																	13.9*	13.9*	37'10"
-7.5 m t																	6.9*	6.9*	10.3
-25 ft lb																	15.1*	15.1*	33'5"
-9.0 m t																	6.5*	6.5*	8.6
-30 ft lb																	14.3*	14.3*	27'5"

Height Can be slewed through 360° In longitudinal position of undercarriage Max. reach * Limited by hydr. capacity

The load values are quoted in tons (t) / lb x 1,000 at stick end (without bucket), and may be swung 360° on firm and even ground. Adjacent values are valid for the undercarriage when in the longitudinal position. Capacities are valid for 750 mm / 30" wide track pads. Indicated loads are based on ISO 10567 standard and do not exceed 75% of tipping or 87% of hydraulic capacity (indicated via *). Without bucket cylinder, link and lever the lift capacities will increase by 825 kg / 1,820 lb / 620 kg* / 1,370 lb*. Lifting capacity of the excavator is limited by machine stability and hydraulic capacity.

* just for stick 5.00 m / 16'5"

Available Buckets

Sticks 2.35 m / 7'9" / 2.90 m / 9'6" / 3.80 m / 12'6"

Mounting	Execution	Width (mm / in)	Capacity (m ³ / yd ³)	Teeth	Number of teeth	Weight (kg / lb)
Direct	STD	1,350 / 53"	1.65 / 2.16	Z 70	3	2,100 / 4,630
Direct	STD	1,550 / 61"	2.00 / 2.62	Z 70	4	2,250 / 4,960
Direct	STD	1,750 / 69"	2.35 / 3.07	Z 70	4	2,450 / 5,400
Direct	STD	1,950 / 77"	2.70 / 3.53	Z 70	5	2,650 / 5,840
Direct	STD	1,950 / 77"	3.00 / 3.92	Z 70	5	2,750 / 6,060
Direct	STD	2,100 / 83"	3.30 / 4.32	Z 70	5	2,850 / 6,280
Direct	HD	1,350 / 53"	1.65 / 2.16	Z 70	3	2,350 / 5,180
Direct	HD	1,550 / 61"	2.00 / 2.62	Z 70	4	2,650 / 5,840
Direct	HD	1,750 / 69"	2.35 / 3.07	Z 70	4	2,850 / 6,280
Direct	HD	1,950 / 77"	2.70 / 3.53	Z 70	5	3,100 / 6,830
Direct	HD	1,950 / 77"	3.00 / 3.92	Z 70	5	3,200 / 7,050
Direct	HD	1,950 / 77"	3.30 / 4.32	Z 70	5	3,250 / 7,170
Direct	HD	2,100 / 83"	3.50 / 4.58	Z 70	5	3,500 / 7,720
SWA 77	STD	1,350 / 53"	1.65 / 2.16	Z 70	3	2,250 / 4,960
SWA 77	STD	1,550 / 61"	2.00 / 2.62	Z 70	4	2,400 / 5,290
SWA 77	STD	1,750 / 69"	2.35 / 3.07	Z 70	4	2,550 / 5,620
SWA 77	STD	1,950 / 77"	2.70 / 3.53	Z 70	5	2,800 / 6,170
SWA 77	STD	1,950 / 77"	3.00 / 3.92	Z 70	5	2,900 / 6,390
SWA 77	HD	1,350 / 53"	1.65 / 2.16	Z 70	3	2,350 / 5,180
SWA 77	HD	1,550 / 61"	2.00 / 2.62	Z 70	4	2,700 / 5,950
SWA 77	HD	1,750 / 69"	2.35 / 3.07	Z 70	4	2,900 / 6,390
SWA 77	HD	1,950 / 77"	2.70 / 3.53	Z 70	5	3,150 / 6,950

Stick 5.00 m / 16'5" (Kinematic R 946 Litronic)

Mounting	Execution	Width (mm / in)	Capacity (m ³ / yd ³)	Teeth	Number of teeth	Weight (kg / lb)
Direct	STD	1,200 / 47"	1.25 / 1.63	Z 50	4	1,300 / 2,865
Direct	STD	1,350 / 53"	1.50 / 1.96	Z 50	4	1,400 / 3,085
Direct	STD	1,500 / 59"	1.75 / 2.29	Z 50	4	1,500 / 3,305
Direct	STD	1,650 / 65"	2.00 / 2.62	Z 50	4	1,600 / 3,525

Serial Equipment

Undercarriage

- Lashing eyes
- Sprocket with dirt ejector
- Track and carrier rollers, sealed and lifetime-lubricated

Uppercarriage

- Access platforms without protruding parts
- Anti-skid surfaces
- Automatic swing brake lock
- Centralized lubrication system (automatic)
- DEF tank filling indicator
- DEF tank lockable access hatch
- Engine hood with gas spring opening
- Extended tool set including tool box
- Handrails
- Lockable fuel tank cap with padlock
- Lockable service doors
- Lockable storage box
- Main switch, manual, lockable
- Protection grid on radiator fan
- Sound insulation
- Swing-out radiators

Hydraulic System

- Dedicated swing circuit
- Filter with integrated fine filters
- Hydraulic pressure measuring ports
- Hydraulic tank shut-off valve
- Magnetic rod
- Pressure accumulator for controlled lowering of equipment with engine turned off

Engine

- Air filter with automatic dust ejector
- Automatic engine idling /speed increase, controlled via joystick sensors
- Common-Rail injection system
- Exhaust gas after-treatment system – SCR
- Fixed geometry turbocharger
- Fuel fine filter
- Fuel pre-filter and water separator
- Fuel priming pump
- Intercooler
- Power Pack US EPA Tier 4 Final
- Stepless adjustable engine speed

Operator's Cab

- 7" multifunction color touchscreen
- Air conditioning, automatic, tri-zone, controlled via display
- Armrests adjustable in width, height and inclination
- Bottle holder
- Cab air filters housing, accessible from ground level
- Cab door sliding windows
- Cigarette lighter
- Coat hook
- DEF consumption on touchscreen
- DEF level on touchscreen
- Electric socket in cabin (12 V)
- Electric socket in cabin (24 V)
- Emergency hammer
- Engine oil level on touchscreen
- Footrest
- Fuel consumption on touchscreen
- Fuel level on touchscreen
- Interior lighting
- Laminated right hand side window
- LIDAT Plus (Liebherr data transfer system)*
- Mechanical hour meters, visible from ground level
- Movement priority for stick-in, adjustable via touchscreen
- Rain hood over front window opening
- Rearview mirror
- Rear view monitoring camera
- Rear window emergency exit
- Right hand side view monitoring camera
- Roll-down sun blinds for windscreen and roof window
- Rubber floor mat, fixed on floor and removable
- Storage box
- Storage nets
- Storage spaces
- Tilttable console left
- Tinted windows
- Visco-elastic damping
- Windscreen wiper and washer
- Work mode selector

Equipment

- Anti-drift system boom cylinders
- Anti-drift system stick cylinder
- Boom cylinders regeneration
- Pipe fracture safety valve for stick cylinder
- Pipe fracture safety valves for boom cylinders
- Pivot points made of cast steel
- SAE split flanges on high pressure lines
- Stick cylinder regeneration

* optionally extendable after one year

Equipment Standard/Option

Undercarriage

Chain guide 3 pieces	•
Chain guide 4 pieces	+
Chain guide full length	+
Reinforced cover and base plate for center section (HD undercarriage)	+
Reinforced cover plate for center section (LC-V undercarriage)	+
Screws protection for sideframe (LC-V undercarriage)	+
Special painting	+
Steps	•
Track pads triple grouser 600 mm/24"	•
Track pads triple grouser 750 mm/30" / 900 mm/35"	+
Travel motor housing protection	+
Undercarriage HD	+
Undercarriage LC-V	+

Uppercarriage

Air pre-filter with cyclonical dust trap	+
Boxing ring	+
Catwalk tiltable front left	+
Catwalks tiltable left and right	+
Centralized lubrication system (automatic)	•
Centralized lubrication system (manual)	+
Counterweight 12.0 t/26,460 lb (hydraulically removable 10.5 t/23,150 lb)	+
Counterweight heavy 11.0 t/24,250 lb	•
Electric socket on uppercarriage (24 V)	+
Headlight on uppercarriage, lateral left, LED+, 1 piece	+ ¹⁾
Headlight on uppercarriage, lateral right, LED+, 1 piece	+ ¹⁾
Headlights on uppercarriage, front, LED, 2 pieces, protections included	• ¹⁾
Headlights on uppercarriage, front, LED+, 2 pieces, protections included	+ ¹⁾
Headlights on uppercarriage, rear, LED+, 2 pieces	+ ¹⁾
Lighting for tank area ¹⁾	+
Lighting for uppercarriage access ¹⁾	+
Pre-heating system for fuel	+
Radiator fine mesh protection grid	+
Reversible fan drive	+
Skyview 360°	+
Special painting	+
Swing ring and lubrication hoses protection	+
Tank refilling pump fuel	+
Uppercarriage bottom and side protection	+
Wiggins coupling for fuel	+

Hydraulic System

Bypass filter for hydraulic oil	+
Liebherr hydraulic oil	•
Liebherr hydraulic oil, adapted for extreme climate conditions	+
Liebherr hydraulic oil, biodegradable	+

Engine

Automatic engine shutdown after idling	+
Engine shut-down with overrun	+
Lighting for engine compartment ¹⁾	+

Operator's Cab

3" seat belt with retractor, orange color	•
4-points seat belt	+
Acoustic travel alarm deactivatable	+
Auxiliary heater programmable	+

• = Standard, + = Option

¹⁾ Equipment not individually available, but only as predefined lighting packages
Non-exhaustive list, please contact us for further information.

Operator's Cab

Bottom windscreen wiper	+
Cool box (12 V)	+
Dark tinted windows	+
Electrically adjustable and heated outside rear-view mirrors	+
Electronic immobilizer	+
Emergency stop in cab	+
FGPS front guard	+
FGPS front guard tiltable	+
Filter for hydraulic hammer return flow	+
Fire extinguisher	+
First-aid box	+
Follow me home	+
FOPS top guard	+
Handrests elevated for joysticks	+
Headlights on cab, front, LED, 2 pieces	• ¹⁾
Headlights on cab, front, LED+, 2 pieces	+ ¹⁾
Headlights on cab roof, front, LED+, 2 pieces	+ ¹⁾
High pressure circuit switchable on pedals or mini-joystick	+
High pressure circuit with Tool Control (20 attachment adjustments on display)	+
Impact resistant one-piece windscreen	+
Impact resistant roof window	+
Integral protection guard	+
Laminated roof window	•
Lighting for cabin access ¹⁾	+
Luminosity control (LED+ headlights) ¹⁾	+
Medium pressure circuit	+
Mini-joysticks proportional	•
Movement restriction for boom	+
Movement restriction for stick	+
Operator seat Comfort	•
Operator seat Premium	+
Overload warning system	+
Radio Comfort	+
Radio pre-installation	•
Retractable laminated two-piece windscreen	•
Roof sun shield	+
Roof window wiper	+
Rotating beacon on cabin, LED, 1 piece	+
Seat belt reminder	+
Shortkey button on joystick configurable	•
Special painting	+
Sun visor	+
Switch between high pressure and bucket cylinder controls	+
Windscreen bottom protection grid	+

Equipment

Boom bottom protection	+
Boom cylinder rods protection	+
Bucket cylinder rod protection	+
Centralized lubrication extended for connecting link	+
Floating boom	+
Headlights on boom, LED, 2 pieces, protections included	• ¹⁾
Headlights on boom, LED+, 2 pieces, protections included	+ ¹⁾
Mono boom 6.70 m/22'	+
Mono boom 7.60 m/24'11"	+
Mono boom 9.20 m/30'2"	+
Mono boom straight 8.00 m/26'3"	+
Preparation for ripper tooth	+
Quick coupler SWA 77 hydraulic	+
Special painting	+
Stick 2.35 m/7'9"	+
Stick 2.90 m/9'6"	+
Stick 3.80 m/12'6"	+
Stick 5.00 m/16'5"	+
Stick bottom protection	+
Tool Management	+

Options and/or special equipments, supplied by vendors other than Liebherr, are only to be installed with the knowledge and approval of Liebherr in order to retain warranty.