

Quick Coupling Systems



LIEBHERR

Liebherr Quick Couplers for Hydraulic Excavators and Material Handling Machines

Liebherr can supply a range of quick couplers to ensure maximum productivity, efficiency and safety on site. Depending on the job and requirement, customers can choose between 3 types of quick coupler: mechanical, hydraulic or the LIKUFIX. Liebherr can also supply a wide range of different quick couplers for material handling machines utilizing suspended attachments.

It is common on any job site to require frequent attachment changes to ensure tasks can be carried out cost effectively. For example, hydraulic excavators used for garden and landscaping frequently change between a backhoe bucket, stone tongs, pallet fork and clamshell grab. Whilst for tougher quarry work, depending on the type of rock, the excavator may change repeatedly between the classic backhoe bucket and a ripper.

Ships with a very wide range of cargoes such as coal, piece goods or timber require flexible handling machines which can be adjusted quickly to the next loading or unloading task. At a scrapyard the operator can change between multi-tine grabs, scrap shears or magnets at the touch of a button thanks to a quick coupling system regardless of whether the change is between a suspended grab or an attachment with bucket kinematics.

Almost any attachment and any hydraulic excavator or handling machine can be fitted or retrofitted with an appropriate quick coupling system.

The use of a hydraulic excavator or a handling machine fitted with a quick coupling system is a basic prerequisite for ensuring that the machine can be operated cost effectively, efficiently and competitively.





Mechanical Quick Coupler

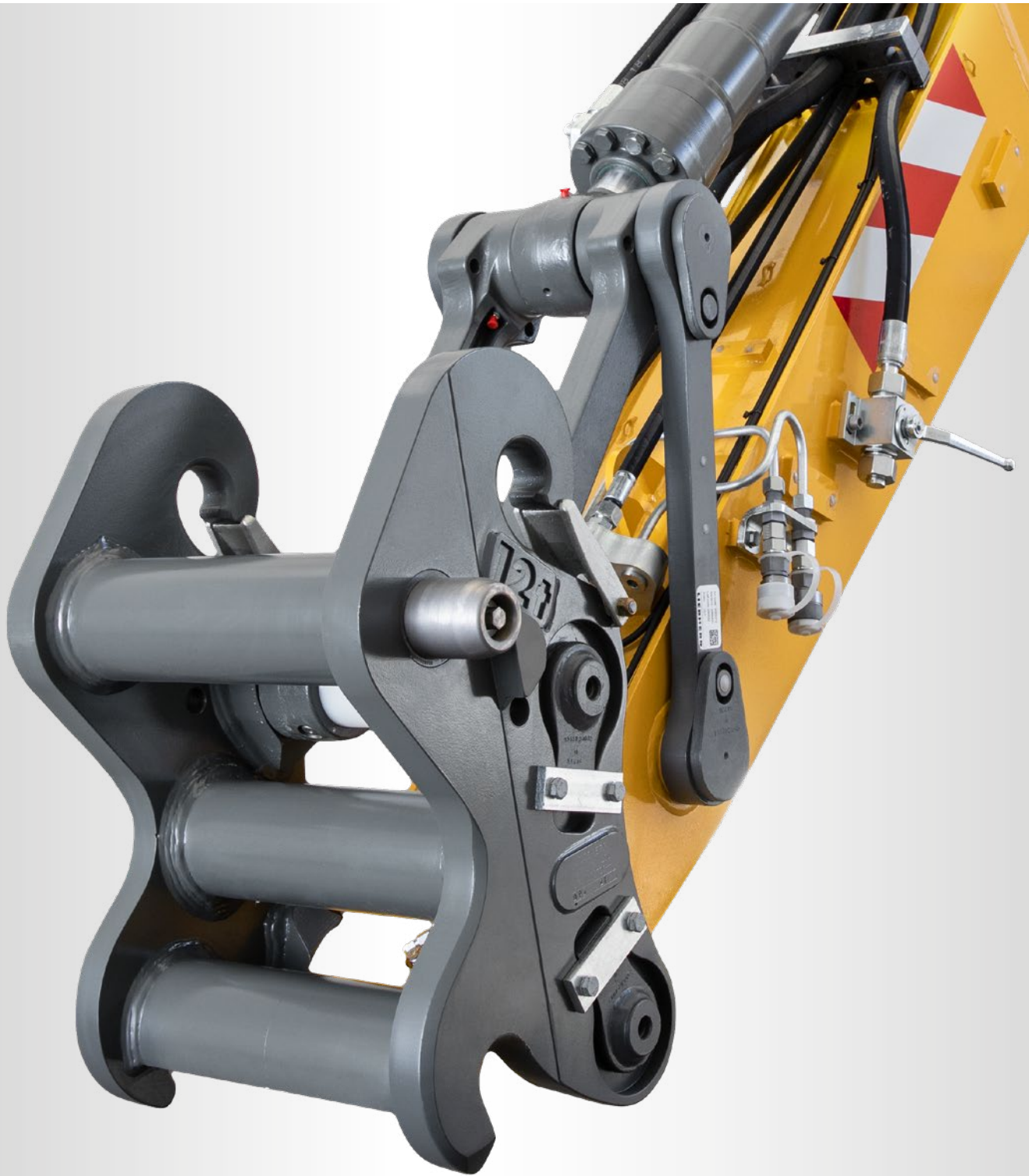

- Manual opening and closing of the quick coupler
- Manual connecting and disconnecting of hydraulic lines

Liebherr's mechanical quick coupler is the perfect solution when aiming to increase the flexibility and productivity of machinery while keeping investment costs to a minimum. The sturdy construction, proven over many years, impresses with its straightforward, safe and reliable mechanical design. After releasing the screw fastening pin, the two locking pins with internal double threading are manually retracted from one side and then reinserted following tool attachment.

A safety latch on the load hook of the quick coupler provides additional safety as it prevents unintentional unhooking of the load. The safety latches on the load hook of the Liebherr quick coupling system offer additional safety. They can bear 100% of the maximum permissible hook load (basic safety) – and thus considerably more than the 10% required by EN 474.

Features and customer benefits

- Straightforward sturdy design for a long service life and low maintenance costs
- Increased machine utilization due to faster tool changing at a low investment cost
- High standard of safety with additional screw fastening pins
- Locking pins with double threading for fast manual releasing and locking from one side
- Load hook equipped as standard with heavy-duty safety latches for increased safety when lifting loads

Areas of application

- For infrequent attachment changes
- For use in the toughest conditions

Hydraulic Quick Coupler

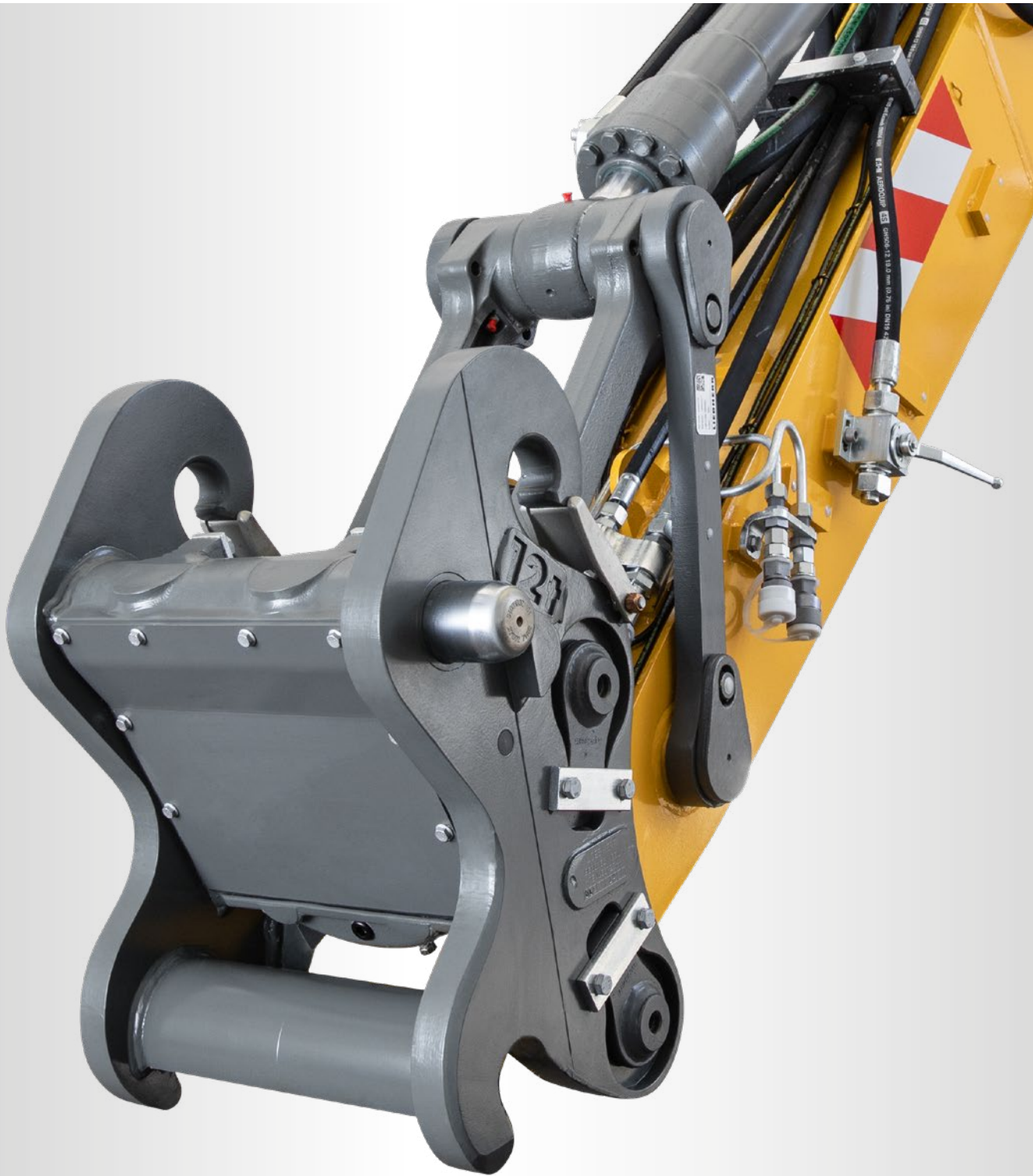

- Opening and closing of the quick coupler at the touch of a button
- Manual connecting and disconnecting of hydraulic lines

Mechanical attachments can be changed effortlessly from the operator's cab at the touch of a button with the Liebherr hydraulic quick coupler. Attachment changeover requires two buttons to be activated simultaneously, which, along with the electronic sensing of the position of the locking pin and the visual check of the left locking pin from the cab, ensures maximum operational safety.

Improved safety thanks to the sturdy heavy-duty safety latches on the load hook: they bear 100 % of the maximum permissible hook load (basic safety) – and thus considerably more than the 10 % required by EN 474.

Features and customer benefits

- Faster safer changing of mechanical attachments from the operator's cab
- Optimum transmission of digging forces like those of directly attached tools
- Unique level of safety when changing tools thanks to the electronic sensor which monitors the position of the locking pin (instead of monitoring the pressure of the locker cylinder)
- Straightforward reliable visual locking check from the operator's cab with a clear view of the left locking pin
- Optical and acoustic warning when the quick coupler is open
- Load hook equipped with heavy-duty safety latches as standard for increased safety when lifting loads
- A proximity sensor monitors the correct position of the attachment in the locking position, thus ensuring additional safety

Areas of application

For frequent tool changes of predominantly mechanical attachments

LIKUFIX

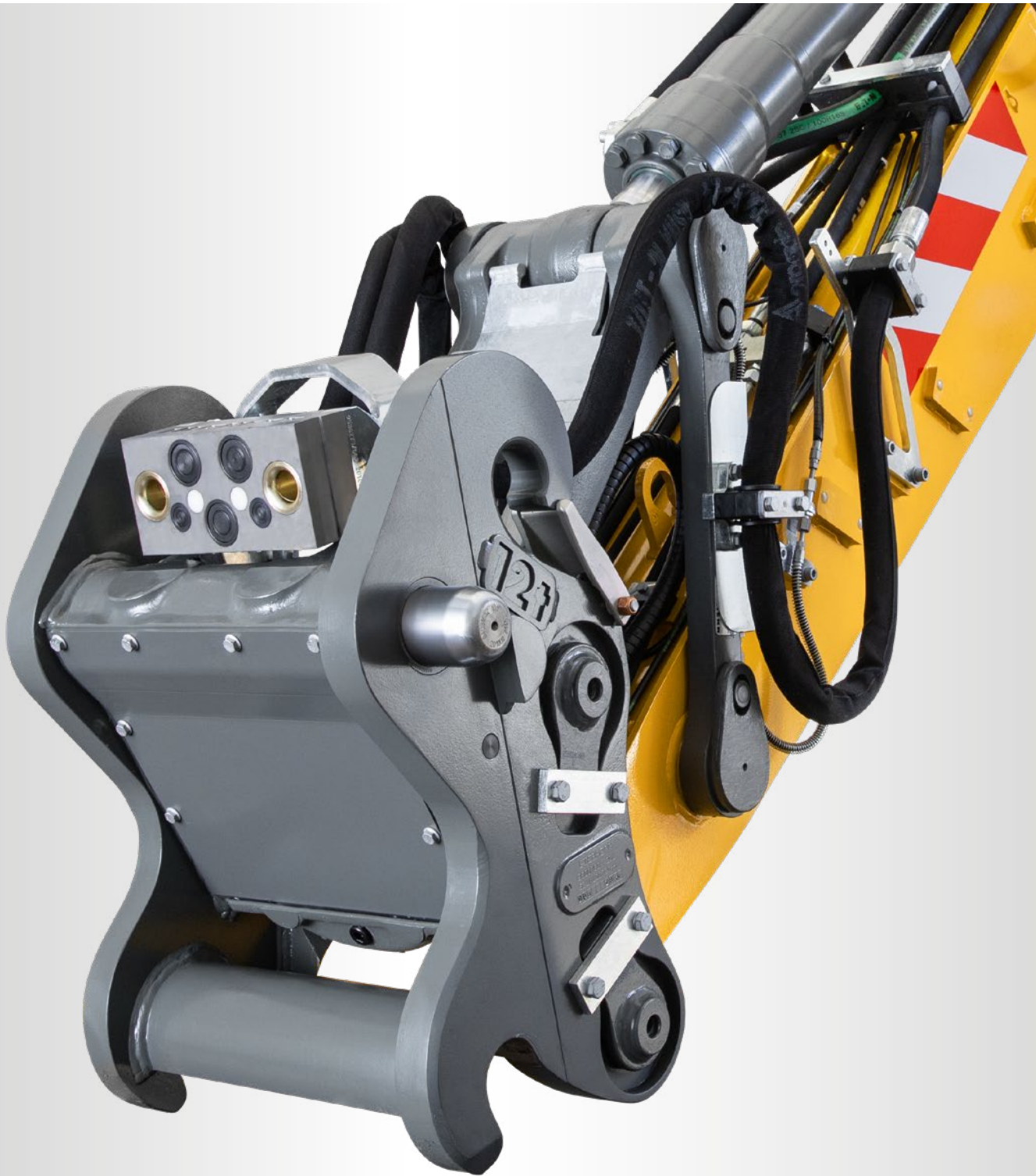

- Opening and closing of the quick coupler at the touch of a button
- Automatic connecting and disconnecting of the hydraulic lines during coupling

LIKUFIX is the fully hydraulic quick coupling system from Liebherr. The combination of a hydraulic Liebherr quick coupler with the LIKUFIX coupling block allows quick changeover of mechanical and hydraulic attachments from the safety of the operator's cab. The deployment options of a hydraulic excavator and machine productivity can thus be increased by up to 30%. A worthwhile investment for over 25 years.

Features and customer benefits

- Faster and safer changing of mechanical and hydraulic attachments from the operator's cab
- Machine utilization can be increased to up to 90% thanks to the added versatility of the machine
- Productivity increased by an average of 30% (based on practical customer experience)
- Maximum flexibility due to add-on options to all hydraulic excavators with operating weights of between 8 and 120 tons
- Unique level of safety when changing tools thanks to the electronic sensor which monitors the position of the locking pin (instead of monitoring the pressure of the locker cylinder)
- Straightforward reliable visual locking control from the operator's cabin with a clear view of the left locking pin
- Optimum fluid flow through hydraulic couplings with large cross-sections for fast tool action and high fuel efficiency
- Hydro-mechanical bearing support of the tool coupling block ensuring the long service life of the hydraulic couplings
- Visual and acoustic warning when the quick coupler is open
- Load hook equipped as standard with heavy-duty safety latches for increased safety when lifting loads
- Reliable electrical connection using special CAN bus-compatible plug
- A proximity sensor monitors the correct position of the attachment in the locking position, thus ensuring additional safety
- Positive locking direction
- Two-handed control

Mounting on attachments and hydraulic excavators of other manufacturers

Practically all hydraulic add-on attachments can be fitted with LIKUFIX. Hydraulic excavators from other manufacturers can be easily fitted with a Liebherr quick coupler or LIKUFIX.

MH 40B LIKUFIX/MH 110B LIKUFIX

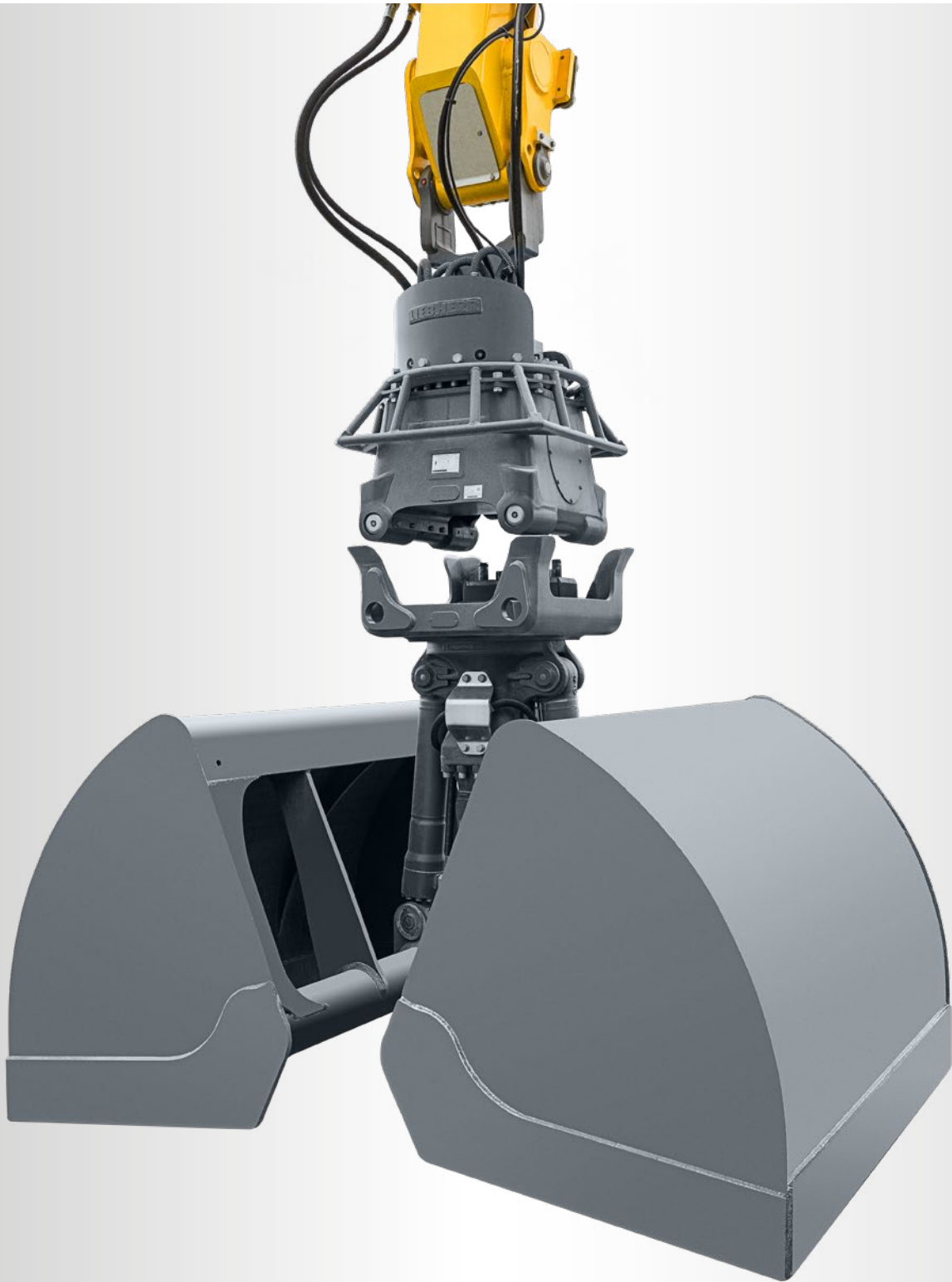

- Opening and closing of the quick coupler at the touch of a button
- Automatic connection and disconnection of the hydraulic lines and electric cables during the coupling process for suspended attachments

Suspended quick coupler for all mechanical, hydraulic and electrical attachments such as multi-tine grabs, clamshell grabs, wood grabs, sorting grabs, magnetic plate, load lift hooks or traverses. During the coupling process, all the hydraulic lines and electric cables (up to 13 kW on the MH 40B/ up to 30 kW on the MH 110B) are connected or disconnected. The top section of the machine is fitted with an integral swivel circuit and can be used for any number of attachments with a bottom section (without a swivel circuit). This means that there is no need for the suspension and swivel drive for any other attachment. This quick coupler enables the hydraulic attachments to be changed easily and conveniently in a matter of seconds without the operator having to leave the cab. This means an enormous increase in the flexibility, productivity and economy of the material handling machine.

Features and customer benefits

- Productivity increased by up to 30 % with the use of hydraulic attachments
- Maximum flexibility as it can be installed on all handling machines with an operating weight between 25 and 150 tonnes
- Change mechanical and hydraulic attachments quickly and safely from the cab without the need for an additional person in the 'danger zone' for changing attachments
- High working speed, no pressure loss and no heating of the couplings thanks to the flow rate of 300 l/min. on the MH 40B/600 l/min. on the MH 110B (continuous operation)
- Spring-loaded LIKUFIX coupling plate to ensure a long service life for the hydraulic couplings
- Simple replacement of the magnetic line using easy access terminal box
- Optional deflector prevents damage when unloading ships (on MH 110B LIKUFIX)

Functions for Increased Productivity

Tool Control

Tool Control is an additional electro-hydraulic function that simplifies work with hydraulic attachments: up to 20 combinations of fluid quantity and pressure can be stored with the tool name, and directly selected via the display unit with touch screen function. With Tool Control the machine operator can easily select the parameters for the required hydraulic tool at the touch of a button – with no complicated re-setting for a tool change. This function is already featured as standard on most hydraulic excavators.



Tool Management (Option)

Tool Management enables automatic tool recognition by the hydraulic excavator. The data stored on the chip in the attachment is read out by the read/write head in the LIKUFIX coupling block on the hydraulic excavator, and transmitted to the operator's control console. The operator acknowledges data at the touch of a button, thus ensuring automatic adjustment of the fluid quantity and pressure. Additionally fluid type and the hours worked with this tool are saved on the chip.



Tool management system read/write head (contact-free, protected)

Electro contacts (Option)

Electrical contacts ensure signals are transferred between the hydraulic excavator and attachment, enabling electrical valves and sensors to be activated for a very wide range of applications. The signals from a locator/GPS receiver can be transferred using the 5-pole round plug on the SWA 48 LIKUFIX, SWA 66 LIKUFIX and SWA 77 LIKUFIX. Other functions, such as operating a second SWA or a switched power socket and actuating the CAN bus are controlled using the 14-pole signal contact strip. On the SWA 33 LIKUFIX, however, the signals from a locator/GPS receiver are transferred using this 14-pole signal contact strip. The contact pins are spring-loaded and design for rugged construction site use.



14-pole signal contact strip

5-pole round plug

Easy Maintenance, Long Service Life

Quick and easy: changing sealing washers on the attachment

The condition of the sealing washers can be checked by pressing down the sealing discs. If replacement is necessary, the sealing washer can be quickly replaced with the help of a screwdriver and a sharp tool.

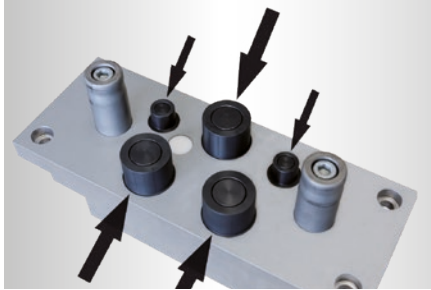

Attachment hydraulic couplings with sealing washers.



Press down sealing disc on the coupling plug with a screwdriver and remove the top sealing washer (red) with a sharp tool.



Press together new sealing washer and place on the sealing disc with the open end facing downwards.



Press sealing disc down as far as the groove, position the screwdriver in the centre of the sealing washer and remove hand.



Allow the sealing washer to jump into the groove.



Remove screwdriver.

- Hydraulic excavator: couplings with maintenance-free metallic washers
- Hydraulic attachments: couplings with sealing washers

Reconditioning

Thanks to replaceable wear parts Liebherr Quick Couplers can be reconditioned quickly and inexpensively to restore them to their 'as new' state. Hydraulic couplings on the attachment and hydraulic excavator can be easily replaced on site by the machine operator.

Productivity with Safety

The use of the right attachment and optimum utilization of the machine contribute to the economical and prompt execution of building projects. Fast and easy tool changeover is essential for high machine utilization and productivity, while also ensuring a high standard of safety. This is only possible if the

operator can see whether the quick coupler and attachment are correctly connected. The Liebherr hydraulic quick coupler allows this option, and thus guarantees maximum productivity and site safety.

- Visual control: straightforward reliable visual locking control visual from the operator's cabin with a clear view of the left locking pin
- Position monitoring: unique level of safety when changing tools afforded by position monitoring of the locking pin and the quick coupling system by electronic position sensors instead of pressure monitoring of the locking cylinder. This satisfies standard ISO 13031 and is the winner of the BG BAU 2016 Innovation Award.
- Alarm signaling: visual and acoustic warning when the quick coupler is open or not locked correctly
- Safety in the event of pressure loss: reliable connection even in the event of pressure loss in the locking cylinder hydraulic line thanks to form-fit coupling
- Safety during load lifting: sturdy heavy-duty safety latches on the load hooks bear 100 % of the maximum permissible hook load (basic safety) for a high standard of safety when transporting heavy loads
- Safety against damage: hydraulic couplings are recessed or integrated into solid metal plates
- Safety against incorrect operation: Designed specifically to reduce danger of damage caused by incorrect operation
- A proximity sensor monitors the correct position of the attachment in the locking position. If the pins are extended during the coupling process without the attachment being connected to the quick coupler, a warning tone sounds in the cab and a warning signal appears on the display





Quick Coupler Sizes for Hydraulic Excavators

Size labelling of the quick coupler correlates to its outer dimensions (e. g. SWA 48).

		Operating weight kg	SWA 22	SWA 33	SWA 48	SWA 66	SWA 77	SWA 92
Quick coupling systems	SWA M echanical		•	•	•	•	•	
	SWA H ydraulic			•	•	•	•	•
	LIKUFIX			•	•	•	•	
Liebherr hydraulic excavator range	Competitor machines	8,000 – 10,000	■	▲				
	A 910 Compact	11,800 – 12,800	■	▲				
	A 912 Compact	12,700 – 13,900	■	▲				
	A 913 Compact	13,900 – 15,500		▲	▲*			
	A 914 Compact	15,200 – 17,500		▲	▲			
	A 914	14,900 – 17,200		▲	▲			
	R 914 Compact	14,900 – 17,400		▲	▲			
	R 914 Rail	19,300 – 20,500		▲	▲			
	A 916 Compact	16,000 – 18,300		▲	▲			
	A 916	16,400 – 18,400		▲	▲			
	A 918 Compact	17,500 – 19,600		▲	▲			
	A 918	17,600 – 19,800		▲	▲			
	R 918	19,550 – 22,650		▲	▲			
	A 920	18,100 – 21,300			▲			
	R 920 Compact	18,750 – 21,900		▲	▲			
	A 922 Rail	19,900 – 22,800		▲	▲			
	R 922	22,250 – 23,750			▲			
	A 924	23,400 – 25,600			▲			
	A 924 Rail	24,500		▲	▲			
	R 924	23,500 – 27,600			▲			
	R 926 Compact	25,400 – 29,500			▲			
	R 926	26,050 – 29,350			▲			
	A 924 Heavy Lift	26,500 – 28,000			▲	▲		
	R 930	30,400 – 32,500			▲	▲		
	R 934	34,800 – 37,200				▲		
	R 936 Compact	33,500 – 34,750			▲	▲		
	R 938	37,300 – 40,400				▲		
	R 945	41,400 – 47,250				▲		
	R 956	51,000 – 60,200					▲	
	R 960 SME	60,000 – 62,850					▲	▲
R 966	66,950 – 70,650						▲	
R 970 SME	78,500 – 80,300						▲	
R 976	85,800 – 93,300						▲	
R 980 SME	95,900 – 101,200						▲	

■ = M ▲ = M/H/L ■ = M*/H*/L* ▲ = H *On request

List of Liebherr Quick Coupling Systems for Hydraulic Excavators

	Direct mounted	Mechanical quick coupler	Hydraulic quick coupler
			
Application	- For earthmoving	- For rare attachment changes - For heavy applications (e. g. tunnel application)	- For frequent attachment changes (mainly mechanical attachments)
Advantages	- Maximum handling performance - Simple technology (only mechanic components)	- Simple technology (only mechanic components) - Low purchasing cost	- Quick change of mechanical attachments - No persons in danger zone (during the change) - Easy retrofitting of LIKUFIX
Additional weight (machine) kg		SWA 33 = approx. 100 SWA 48 = approx. 200 SWA 66 = approx. 350	SWA 33 = approx. 110 SWA 48 = approx. 220 SWA 66 = approx. 430
Opening and closing quick coupler		manually	hydraulically
Connecting and disconnecting hydraulic lines		manually	manually
Time and personnel costs (to change a <u>mechanical</u> attachment)	approx. 25 min. (2 persons)	approx. 10 min.	< 1 min.
Time and personnel costs (to change a <u>hydraulic</u> attachment)	approx. 45 min. (2 persons)	approx. 25 min.	approx. 15 min.

* Only possible with 14-pole signal contact strip

Hydraulic quick coupler + hydraulic coupling system = LIKUFIX

Tool Control

Tool Management

(only in combination with LIKUFIX SWA 48 / SWA 66 / SWA 77)

Electric contacts

(only in combination with LIKUFIX SWA 33* / SWA 48 / SWA 66 / SWA 77)



- For regular attachment changes
- For canal construction, civil engineering and demolition

- 20 memory slots for attachment data in the hydraulic excavator (oil pressure and oil flow)

- Automatic attachment recognition (transmission of all relevant attachment data to the excavator)

- Automatic attachment recognition (transmission of all relevant attachment data to the excavator)

- Quick change of mechanical and hydraulic attachments
- No persons in danger zone

- Fast manual setting of the required attachment data at the push of a button (oil pressure and oil volume)

- Easy analysis and post calculation (attachment working hours saved on attachment chip)
- Protection from accidental misuse

Enables the following functions:

- 5-pin signal contact plug:
- The transfer of signals from a locator / GPS receiver (using the 14-pole signal contact strip on the SWA 33)

- 14-pole signal contact strip:
- Operation of a second SWA
 - Operation of a switched power socket
 - CAN bus activation

SWA 33 LIKUFIX = approx. 130
 SWA 48 LIKUFIX = approx. 255
 SWA 66 LIKUFIX = approx. 490

hydraulically

automatically

< 1 min.

< 1 min.

Quick Coupler Sizes for Industrial Machines with Suspended Attachments

	Operating weight kg	Quick coupler industrial stick (hydraulically)	Multi coupling system	MH 40B LIKUFIX	MH 110B LIKUFIX
LH 18	17,000 – 18,000				
LH 22	19,200 – 21,900		•		
LH 24	22,700 – 23,200	•	•	•	
LH 26	24,200 – 24,500	•	•	•	
LH 30	26,500 – 30,200	•	•	•	
LH 35	29,600 – 31,900	•	•	•	
LH 40	36,400 – 50,100	•	•	•	
LH 50	40,000 – 43,500	•	•	•	•
LH 50 HR	46,400 – 54,900	•	•	•	•
LH 60	55,000 – 62,000	•	•		•
LH 60 HR	67,300 – 75,800	•	•		•
LH 80	71,500 – 80,400	•	•		•
LH 80 HR/G	86,500 – 112,500	•	•		•
LH 110	95,000 – 115,000	•	•		•
LH 110 HR/G	100,000 – 120,000	•	•		•
LH 150	130,000 – 155,000	•	•		•
LH 150 HR/G	135,000 – 175,000		•		•



Quick Coupler Sizes for Industrial Machines with Bucket Kinematics

Size labelling of the quick coupler correlates to its outer dimensions (e. g. SWA 48).

		Operating weight kg	SWA 33	SWA 48	SWA 66
Quick coupling systems	SWA M echanical		•	•	•
	SWA H ydraulic		•	•	•
	L IKU F IX		•	•	•
	L IKU F IX S hear stick			•	•
Liebherr material handler models	LH 18	17,000 – 18,000	▲	▲	
	LH 22	19,200 – 21,900	▲	▲	
	LH 24	22,700 – 23,200		▲	
	LH 26	24,200 – 24,500		▲/LS	
	LH 30	26,500 – 30,200		▲/LS	
	LH 35	29,600 – 31,900		▲/LS	
	LH 40	36,400 – 50,100		▲	LS
	LH 50	40,000 – 43,500		▲	LS
	LH 50 HR	46,400 – 54,900		■	
	LH 60	55,000 – 62,000			
	LH 60 HR	67,300 – 75,800			
	LH 80	71,500 – 80,400			
	LH 80 HR/G	86,500 – 112,500			
	LH 110	95,000 – 115,000			
	LH 110 HR/G	100,000 – 120,000			
	LH 150	130,000 – 155,000			
LH 150 HR/G	135,000 – 175,000				

■ = M ▲ = M/H/L ■ = M*/H*/L* ▲ = H LS = LIKUFIX Shear stick * On request

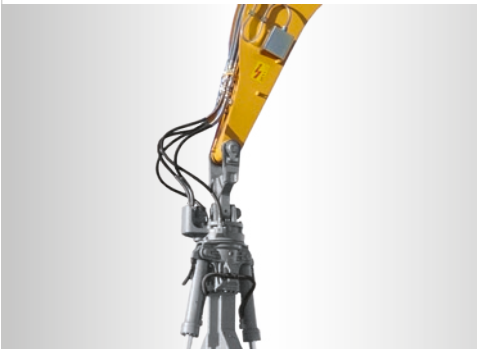
Manual/Semi-Automatic Quick Coupling Systems for Material Handling Machines

	Direct mounted	Mechanical quick coupler
		
Usable attachments	- All suspended attachments with industrial stick	- All suspended attachments with industrial stick and quick coupler holder
Type of application	- For very infrequent or no attachment changes	- For infrequent attachment changes
Area of application	- For applications where only one material type is being handled at a time (e. g. timber only, scrap only, etc.)	- For applications where the material being handled varies (e. g. grain, ore, coal in port handling)
Advantages	- Maximum handling rates - Best fuel efficiency (tons per litre Diesel)	- Simple technology (e. g. for export countries) - Cost-effective investment
Disadvantages	- No flexibility	- Minimally lower load lift because of additional weight of the quick coupler
Additional weight (machine) kg	0	90
Additional structural height (machine) mm	0	170
Attachment change	manually	manually
Connection / disconnection of hydraulic lines	Single manual	Single manual
Time and personnel costs (to change an attachment)	approx. 25 min. (2 persons)	approx. 30 min. (1 person)
Persons in danger zone	yes (risk of accidents with bolts)	approx. 30 min. (1 person)
Optional scales: mounting on the machine possible	yes	yes
Optional scales: mounting on the attachment required	no	no

Quick coupler industrial stick (hydraulically)



Quick coupler industrial stick (hydraulically)

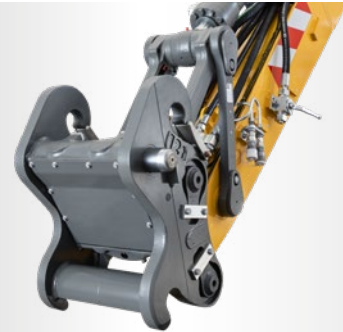

- All suspended tools with industrial stick and quick coupler holder

- Sorting grab, stick extension and all suspended attachments with tilt kinematics stick

- For frequent attachment changes

- For frequent attachment changes

- Scrap handling
- Timber handling
- Port handling
- Recycling applications

- Scrap handling
- Timber handling
- Port handling
- Recycling applications

- Quick mounting/removal of the attachment (without hydraulic lines)

- Quick mounting/removal of the attachment (without hydraulic lines)

- Slightly lower load lift due to the additional weight of the quick coupler

- Lower load lift due to the additional weight of the quick coupler

75

110 (SWA 33)
240 (SWA 48)
395 (SWA 66)

0

150 (SWA 33)
200 (SWA 48)
240 (SWA 66)

hydraulically

hydraulically

Single manual

Single manual

approx. 20 min.
(1 person)

approx. 20 min.
(1 person)

no

no

no

no

yes

yes

Fully Automatic Quick Coupling Systems for Material Handling Machines

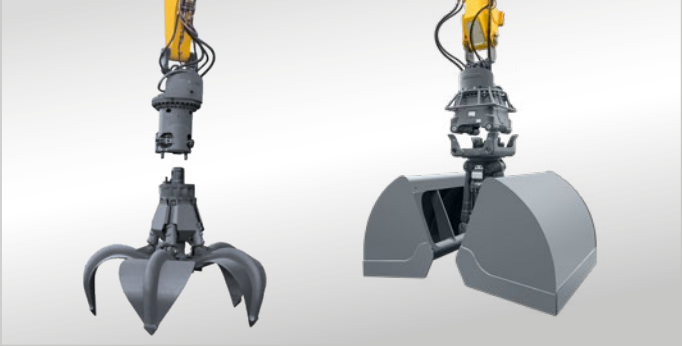
	MH 40B LIKUFIX / MH 110B LIKUFIX
	
Possible attachments	- All attachments with MH 40B mounting / MH 110B mounting
Type of application	- For regular attachment changes
Area of application	- Material handling - Material sorting
Advantages	- Change between hanging attachments in seconds
Disadvantages	- Lower load lift because of additional weight of quick coupler - Additional components
Additional weight (machine) kg	MH 40B LIKUFIX approx. 390 MH 110B LIKUFIX approx. 490
Additional structural height (machine) mm	approx. 500
Attachment change	hydraulically
Connection / disconnection of hydraulic lines	automatically
Time and personnel costs (to change an attachment)	< 1 min.
Persons in danger zone	no (can be changed from the cab)
Optional scales: mounting on the machine possible	yes
Optional scales: mounting on the attachment required	no

LIKUFIX 33/48/66/77
(long stick with tilt kinematics)



LIKUFIX 48/66/77
(short stick with tilt kinematics for heavy attachments)



- Sorting grap and suspended attachments with LIKUFIX holder

- For regular attachment changes

- Material handling
 - Material sorting
 - Other applications (universal machine)

- Change between guided / suspended attachments in seconds

- Lower load lift because of additional weight of quick coupler
 - Additional components

SWA 33 LIKUFIX = 130
 SWA 48 LIKUFIX = 650 up to 900
 SWA 66 LIKUFIX = 1,350 up to 1,850
 SWA 77 LIKUFIX = 2,200
 (incl. tilt kinematics and quick coupler)

-

hydraulically

automatically

< 1 min.

no (can be changed from the cab)

yes

no

- Scrap shears and all suspended attachments with LIKUFIX holder and stick extension

- For regular attachment changes

- Material cutting with scrap shears
 - Material handling by multi-tine grap with stick extension

- Change between guided / suspended attachments in seconds

- Lower load lift because of additional weight of quick coupler
 - Additional components

SWA 48 LIKUFIX = 1,150 approx.
 SWA 66 LIKUFIX = 2,100 approx.
 SWA 77 LIKUFIX = 3,500 approx.
 (incl. tilt kinematics, quick coupler and stick extension)

-

hydraulically

automatically

< 1 min.

no (can be changed from the cab)

yes

no

The Liebherr Group of Companies



Wide Product Range

The Liebherr Group is one of the largest construction equipment manufacturers in the world. Liebherr's high-value products and services enjoy a high reputation in many other fields. The wide range includes domestic appliances, aerospace and transportation systems, machine tools and maritime cranes.

Exceptional Customer Benefit

Every product line provides a complete range of models in many different versions. With both their technical excellence and acknowledged quality, Liebherr products offer a maximum of customer benefits in practical applications.

State-of-the-art Technology

To provide consistent, top quality products, Liebherr attaches great importance to each product area, its components and core technologies. Important modules and components are developed and manufactured in-house, for instance the entire drive and control technology for construction equipment.

Worldwide and Independent

Hans Liebherr founded the Liebherr family company in 1949. Since then, the family business has steadily grown to a group of more than 130 companies with nearly 44,000 employees located on all continents. The corporate headquarters of the Group is Liebherr-International AG in Bulle, Switzerland. The Liebherr family is the sole owner of the company.

www.liebherr.com