

Standard and Optional Equipment

●=Std ○=Opt

Category	Description	SK350LC-11	SK390LC-11	
		LC	H&W	
Engine	ISUZU 6HK1 (Tier IV Final certified)	●	●	
	Auto engine acceleration/deceleration	●	●	
	Auto Idle Stop	●	●	
Hydraulic system	3 work modes H, S, Eco	●	●	
	Power boost	●	●	
	Heavy lift mode	●	●	
	Hydraulic Pressure Release	●	●	
	Independent travel	●	●	
	Single pedal travel	●	●	
	Swing priority	●	●	
	Boom to arm regeneration	●	●	
	Auto warm-up system	●	●	
	Bi-direction (proportional hand control) and single-direction auxiliary hydraulics (nibbler and breaker)	●	●	
	Rotation hydraulics with proportional hand control	○	○	
	Hydraulic oil VG46	●	●	
	Cabin	Air suspension seat with heat	●	●
		10-inch color monitor	●	●
LED door light		●	●	
Automatic climate control		●	●	
Radio (AM/FM, AUX, USB, Bluetooth® and hands-free telephone)		●	●	
12V power outlet		●	●	
7 LED work lights: 2 on boom, 2 on cab front, 2 on rear counterweight, 1 on front right		●	●	
Working equipment	Standard HD boom 21'4" (6.50 m) with large diameter boom cylinder	●	●	
	Standard HD arm 10'10" (3.30 m) with rock guard	●	○	
	Short HD arm 8'6" (2.60 m) with rock guard	○	○	
	Long HD arm 13'7" (4.15 m) with rock guard	○	●	
	Standard C/W 16,780 lb (7,610 kg) with swing flashers	-	-	
Counterweight	Semi Heavier C/W 19,010 lb (8,620 kg) with swing flashers	●	-	
	31.5" (800 mm) triple grouser shoe	●	○	
Undercarriage	31.5" (800 mm) single grouser shoe	○	-	
	35.4" (900 mm) triple grouser shoe	○	-	
	27.6" (700 mm) double grouser shoe	-	●	
	High and Wide lower frame	-	●	
	Track guides (three per side)	●	-	
	Lower swivel guard	●	●	
	ROPS cab (ISO 12117-2:2008)	●	●	
Safety	Tilt opening top cab guard (Top guard level II ISO 10262:1998)	●	●	
	Bar-type front guard (Front guard level II ISO 10262:1998)	○	○	
	Mesh-type front guard (Front guard level I ISO 10262:1998)	○	○	
	Engine emergency stop switch	●	●	
	3-inch retractable seat belt	●	●	
	Seatbelt indicator on display	●	●	
	Travel alarm	●	●	
	Swing flashers in counterweight	●	●	
	Left and right side mirrors	●	●	
	3-side 270-degree camera system	●	●	
	Hose burst valve for boom and arm cylinder	○	○	
	Others	Angled upper deck guards	●	●
		Machine Guidance ready brackets	●	●
		Quick coupler piping ready brackets	●	●
ISO to BHL pattern changer		●	●	
Battery disconnect switch		●	●	
KOMEXS Machine Monitoring		●	●	
4 Year or 4,000 Hour Warranty		●	●	
Single pedal travel		●	●	

Note: Bluetooth® is a registered trademark of the Bluetooth SIG Inc.

Note: This catalog may contain attachments and optional equipment that are not available in your area. And it may contain photographs of machines with specifications that differ from those of machines sold in your areas. Please consult your nearest KOBELCO distributor for those items you require. Due to our policy of continuous product improvements all designs and specifications are subject to change without advance notice.

Copyright by KOBELCO CONSTRUCTION MACHINERY CO., LTD. No part of this catalog may be reproduced in any manner without notice.

KOBELCO CONSTRUCTION MACHINERY U.S.A. INC.

22350 Merchants Way, Katy, TX 77449
 Tel: 281-888-8430 Fax: 281-506-8713
 www.KOBELCO-USA.com

Inquiries To:

KOBELCO is the corporate mark used by Kobe Steel on a variety of products and in the names of a number of Kobe Steel Group companies.

Bulletin No. SK350-SK390LC-11-NA-201-2301ONE

KOBELCO

Hydraulic Excavator

-11 SERIES

SK350_{LC}

SK390_{LC}

Performance  Design

■ Engine Power:

265 hp {198 kW} @ 1,900 rpm
(SAE NET)

■ Operating Weight:

84,200 lb {38,200 kg}–85,500 lb {38,800 kg}



Complies with the latest exhaust emission regulations 



Performance Design

PERFORMANCE BY DESIGN

The next generation of KOBELCO excavators brings together superior performance and thoughtful design like never before. Performance enhancements offer greater efficiency and productivity along with increased speed. Design improvements provide the ultimate in comfort and control.

KOBELCO refuses to compromise by creating machines that meet every challenge.



EXCEPTIONAL PERFORMANCE JUST GOT EVEN BETTER

Higher Efficiency, Plus a Tier IV Final Compliant Engine

The new SK350LC is equipped with a Isuzu Tier IV Final compliant engine, which has a higher torque value. Superior balance between engine output and torque contributes to more efficient performance than the previous models. In addition, the DPF replacement interval has been extended.

Model: ISUZU 6HK1

Engine Output

265 hp {198 kw} / 1,900 rpm (SAE NET)

Independent Travel

Selecting Independent Travel dedicates one hydraulic pump to travel and one to the attachment on a continuous basis, allowing for a smooth and constant movement speed even while swinging or using the boom or attachment. With Independent Travel, safely carrying a large pipe across a jobsite is a breeze.

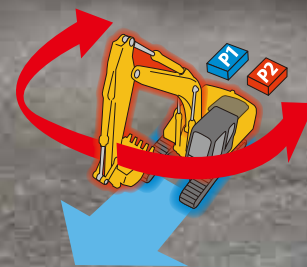

Lifting Capacity

32,480 lb
{14,730 kg}

(High and Wide, 13'7" arm, heavy lift, ground level @ 20')

Bucket Digging Force

56,200 lb
{250 kN}

(10'10" arm with power boost engaged)





SAFETY ON FULL DISPLAY

Standard 3 Sides Safety Camera System

Our high-resolution, large display shows right, left and rear side cameras together. Multiple display allows the operator to customize viewing needs to enhance operator awareness and jobsite safety.



Large 10-Inch Color Monitor

The easy-to-operate menu screen and recognizable icons assist the operator to select the most important information needed to ensure jobsite safety and machine control.



Dial in the Right Information

Simply turn the jog dial to the right or left to select an operational feature, then press the dial to confirm selection.





PREMIER OPERATOR COMFORTS

Heated Air Ride Suspension Seat

A 7-way adjustable seat achieves excellent shock absorption and superior ride comfort.

Multi Vent Air Conditioner

Cool air is blown from multiple outlets toward the operator's body for more comfortable operation.

Ergonomic Lever Angles

Operators can move levers horizontally without twisting their wrists, reducing fatigue.



Adjustable Height Joysticks

Joystick height is manually adjustable to suit operator's preference.

LED Interior Light

Interior lights turn on and off automatically when the door is open or the ignition is turned to the OFF position. This ensures safe entry and exit in the dark.

Tilting Left Side Console

Flip-up left console with integrated pilot control lock lever tilts for easy entry and exit from the cab.



THE ULTIMATE IN SIMPLE DESIGN

In our pursuit of functional beauty and styling, we created an all new interior design focused with the operator in mind.

Jog Dial

This dial integrates multiple functions into a single, easy to use interface. Even with gloves on, the operator can make the adjustments they need.

LED Illumination

Dials and buttons are now backlit to provide a bright, clear view in any lighting condition.



GREATER MULTI-FUNCTION CAPABILITIES

Attachment Mode Selection

The auxiliary flow rates for the bucket, breaker, nibbler and thumb are all now adjustable by the operator through the monitor, allowing you to change tools quickly and easily. Mode settings for other attachments like the tilt rotator can be added or changed.



EASY MAINTENANCE



Standard Overhead Top Guard Level II

The standard overhead cab guard can be tilted open with gas damper for easy window cleaning. Meets standard top guard level II requirements. (ISO 10262)



Engine Maintenance

Lower service platform makes engine service easier.



Two-Stage Air Filter



DEF Tank

The DEF fill is located inside the locking tool box.



Left Side (Radiator and Cooling System Elements)

Laid out for easy access to radiator and cooling system with clean out screen.



Right Side (Ground Level Maintenance)

Hydraulic pump and engine filter compartment.



Engine Oil Filter / Pre-Filter with Integrated Water Separator



Fuel Filter

DURABILITY YOU CAN TRUST

Heavier Door Panels and Supports for Added Body Rigidity

Newly designed and reinforced rear right and left doors provide added protection for the radiator and pump compartments.



Angled Upper Deck Guards

Angled upper deck guards run along the side of the upper body to protect door panels from impact and damage.

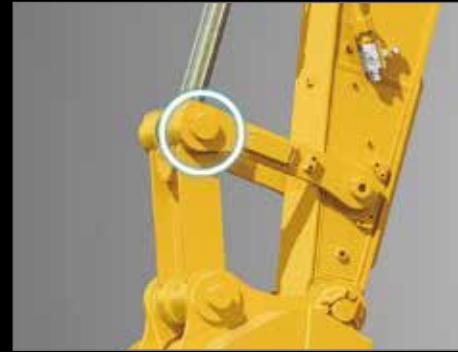

Bucket Cylinder Rod Pin

The increased diameter of the bucket cylinder rod pin contributes to enhanced durability for various types of attachments.
(Bucket pin dimensions have not changed from previous models.)

SAFETY AND CONVENIENCE IN EVERY CORNER



Adjustable Height Joystick Consoles

The operator can adjust height of attachment control levers.



Hands-Free Bluetooth® Phone Calls



USB Charging Port / 12V Power Outlet



Smartphone Holder

Includes USB port for charging.



Single Pedal Travel

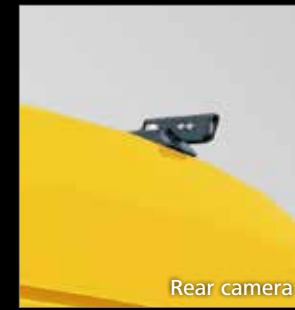

Rear camera

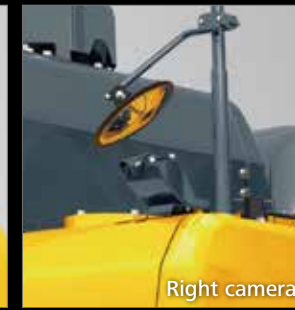

Right camera



Left camera

Standard Rear, Left and Right Side Cameras



Swing Flashers for a Safer Jobsite

Standard swing flashers notify ground workers that the machine is swinging.

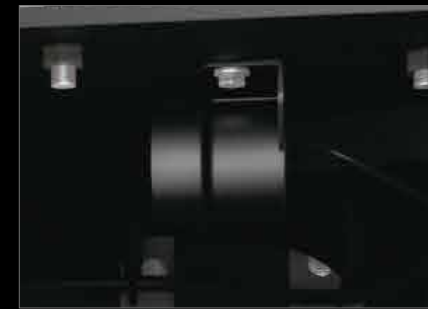

Travel Alarm



2 on boom (Left & Right)



2 on counterweight



1 on upper frame



2 on cab top front

Standard 7 LED Lights

Bright LED lights ensure visibility even during night work.



Wire Mesh or Vertical Bar Front Cab Guard (optional)

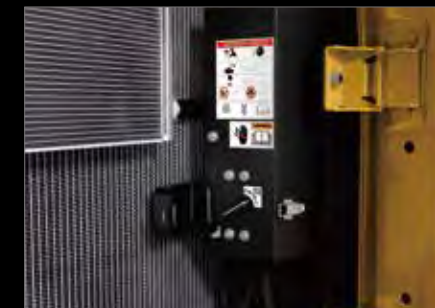

Battery Disconnect Switch with DEF Purge Notification Buzzer



Quick Coupler Piping Brackets



Arm



Boom



Bucket link



Counterweight

Machine Guidance Ready Brackets

Pre-welded brackets for quicker and easier installation of Machine Guidance Systems.



KOBELCO MONITORING EXCAVATOR SYSTEM



Remote Monitoring for Peace of Mind

KOMEXS (Kobelco Monitoring Excavator System) uses satellite communication and internet to relay data, and therefore can be deployed in areas where other forms of communication are difficult. When a hydraulic excavator is fitted with this system, data on the machine's operation, such as operating hours, location, fuel consumption, and maintenance status can be obtained remotely.

Direct Access to Operational Status

Location Data

• Accurate location data can be obtained even from sites where communications are difficult.

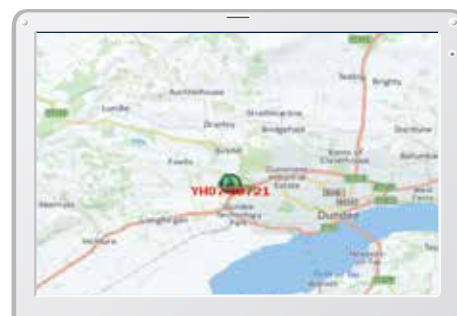

Latest location

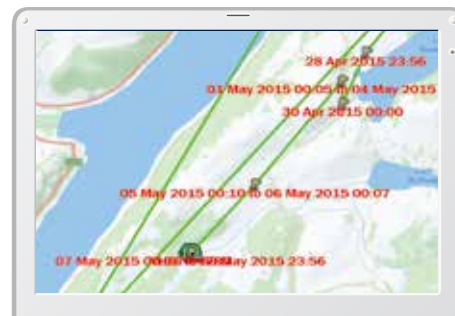

Location records



Work data

Operating Hours

- A comparison of operating times of machines at multiple locations shows which locations are busier and more profitable.
- Operating hours on site can be accurately recorded, for running time calculations needed for rental machines, etc.

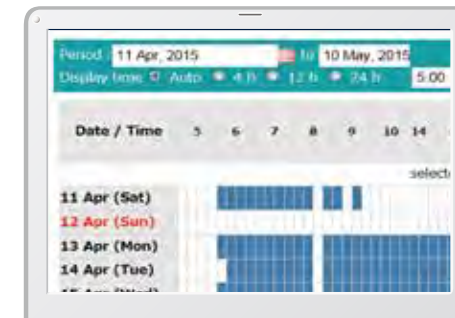

Daily report

Fuel Consumption Data

- Data on fuel consumption and idling times can be used to indicate improvements in fuel consumption.

Work mode	Working Hrs	Total Fuel Consumption
H mode	2:06	24.5 L
S mode	0:00	0.0 L
E mode	169:19	1489.7 L
TOTAL	171:25	1514.2 L

Fuel consumption

Graph of Work Content

- The graph shows how working hours are divided among different operating categories, including digging, idling, travelling and optional operations.



Work status

Maintenance Data and Warning Alerts

Machine Maintenance Data

- Provides maintenance status of separate machines operating at multiple sites.
- Maintenance data is also relayed to KOBELCO service personnel, for more efficient planning of periodic servicing.

Model	Serial No.	Hour Meter	Engine Oil
SK135SLC-3/SK140SRL	YH07-09721	734 Hr	434
SK135SLC-3/SK140SRL	YH07-09789	73 Hr	429
SK210LC-9	Y013-10454	960 Hr	58
SK210LC-9	Y013-10481	549 Hr	498
SK75SR	YT08-30374		

Maintenance

Warning Alerts

- This system warns an alert if an anomaly is sensed, preventing damage that could result in machine downtime.

Alarm Information Can Be Received through E-mail

- Alarm information or maintenance notice can be received through E-mail, using a computer or cell phone.

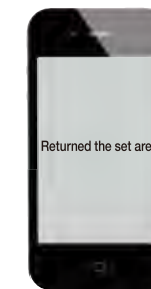

Alarm messages can be received on mobile device.

Daily/Monthly Reports

- Operational data downloaded onto a computer helps in formulating daily and monthly reports.

Security System

Engine Start Alarm

- The system can be set an alarm if the machine is operated outside designated time.



Engine start alarm outside prescribed work time

Area Alarm

- It can be set an alarm if the machine is moved out of its designated area to another location.



Alarm for outside of reset area

Specifications

Engine

Model	ISUZU 6HK1
Type	Direct injection, water-cooled, 4-cycle diesel engine with turbocharger, intercooler, Tier IV Final certified
No. of cylinders	6
Bore and stroke	4.5" x 4.9" {115 mm x 125 mm}
Displacement	475.4 cu.in {7.790 L}
Rated power output	265 hp {198 kW} / 1,900 rpm (SAE NET) 282 hp {210 kW} / 1,900 rpm (Without fan)
Max. torque	745 lb-ft {1,011 N·m} / 1,500 rpm (SAE NET) 797 lb-ft {1,080 N·m} / 1,500 rpm (Without fan)

Hydraulic System

Pump	
Type	Two variable displacement pumps + one gear pump
Max. discharge flow	2 x 77.7 gpm {2 x 294 L/min} 1 x 5.0 gpm {1 x 19 L/min}
Relief valve setting	
Boom, arm and bucket	4,970 psi {34.3 MPa}
Power Boost	5,480 psi {37.8 MPa}
Travel circuit	4,970 psi {34.3 MPa}
Swing circuit	4,210 psi {29.0 MPa}
Control circuit	725 psi {5.0 MPa}
Pilot control pump	Gear type
Main control valve	8-spool
Oil cooler	Air cooled type

Swing System

Swing motor	Axial piston motor
Brake	Hydraulic; locking automatically when the swing control lever is in neutral position
Parking brake	Oil disc brake, hydraulic operated automatically
Swing speed	10.0 rpm
Swing torque	88,500 lb-ft {120 kN·m}

Hydraulic P.T.O.

Specification	Output	Maximum pressure psi {MPa}	Max. flow U.S. gpm, {lpm}
			(0 pressure)
Auxiliary		4,970 {34.3}	2 x 77.7 {2 x 294}
Rotation		3,263 {22.5}	11.7 {44.3}

Operating Weight & Ground Pressure

In standard trim, with standard boom, 10'10" {3.30 m} arm, and 1.83 cu.yd. {1.40 m³} ISO heaped bucket

Shaped		Single grouser shoes (even height)	Triple grouser shoes (even height)	
Shoe width	ft-in {mm}	31.5" {800}	31.5" {800}	35.4" {900}
Overall width of crawler	ft-in {mm}	11'1" {3,390}	11'1" {3,390}	11'5" {3,490}
Ground pressure	psi {kPa}	7.7 {53}	7.8 {54}	7.0 {48}
Operating weight	lb {kg}	83,600 {37,900}	84,200 {38,200}	84,900 {38,500}

Travel System

Travel motors	2 x axial-piston, two-step motors
Travel brakes	Hydraulic brake per motor
Parking brakes	Oil disc brake per motor
Travel shoes	48 each side
Travel speed	3.7/2.2 mph {5.8/3.6 km/h}
Drawbar pulling force	71,900 lb {320 kN}
Gradeability	70% {35°}

Cab & Control

Cab
All-weather, sound-suppressed steel cab mounted on silicon-sealed viscous mounts and equipped with a heavy, insulated floor mat.
Control
Two hand levers and two foot pedals for travel
Two hand levers for excavating and swing
Electric rotary-type engine throttle

Boom, Arm & Bucket

Boom cylinders	5.9" {150 mm} x 5'1" {1,542 mm}
Arm cylinder	6.7" {170 mm} x 5'10" {1,788 mm}
Bucket cylinder	5.9" {150 mm} x 3'11" {1,193 mm}

Refilling Capacities & Lubrications

Fuel tank	132.9 U.S.gal {503 L}
Cooling system	10.8 U.S.gal {41 L}
Engine oil	12.8 U.S.gal {48.6 L}
Travel reduction gear	2 x 2.1 U.S.gal {8 L}
Swing reduction gear	2.0 U.S.gal {7.4 L}
Hydraulic oil tank	64.7 U.S.gal {245 L}: Tank oil level 108.3 U.S.gal {410 L}: Hydraulic system
DEF tank	21.9 U.S.gal {83 L}

Working Ranges

Unit: ft-in {m}

Range	Arm	21'4" {6.50m}		
		Short 8'6" {2.60m}	Standard 10'10" {3.30m}	Long 13'7" {4.15m}
a- Max. digging reach		34'10" {10.61}	36'11" {11.26}	39'3" {11.97}
b- Max. digging reach at ground level		34'1" {10.40}	36'3" {11.06}	38'8" {11.79}
c- Max. digging depth		21'10" {6.65}	24'1" {7.35}	26'11" {8.21}
d- Max. digging height		34'3" {10.45}	35'5" {10.79}	35'11" {10.94}
e- Max. dumping clearance		23'8" {7.22}	24'9" {7.55}	25'5" {7.74}
f- Min. dumping clearance		11'3" {3.43}	8'11" {2.72}	6'1" {1.86}
g- Max. vertical wall digging depth		19'2" {5.84}	21'7" {6.58}	23'10" {7.27}
h- Min. swing radius		14'1" {4.28}	13'7" {4.14}	13'11" {4.25}
i- Horizontal digging stroke at ground level		13'10" {4.21}	19'1" {5.82}	23'8" {7.21}
j- Digging depth for 8' {2.4 m} flat bottom		21'3" {6.48}	23'7" {7.20}	26'6" {8.08}
Bucket capacity SAE heaped cu.yd. {m ³ }		2.09 {1.60}	1.83 {1.40}	1.57 {1.20}

Digging Force (ISO 6015)

Unit: lb {kN}

Arm length		Short 8'6" {2.60m}	Standard 10'10" {3.30m}	Long 13'7" {4.15m}
Bucket digging force	SAE		45,900 {204}	50,600 {225}*
	ISO		51,000 {227}	56,200 {250}*
Arm crowding force	SAE	44,100 {196}	37,100 {160}	30,800 {137}
	ISO	48,600 {216}*	39,600 {176}*	33,700 {150}*

*Power Boost engaged.

Dimensions

Unit: ft-in {mm}

Arm length	Short 8'6" {2.60m}	Standard 10'10" {3.30m}	Long 13'7" {4.15m}
A Overall length	37'4" {11,380}	37'1" {11,300}	
B Overall height (to top of boom)	12'1" {3,690}	11'3" {3,420}	11' 9" {3,580}
C Overall width		11'1" {3,390}**	
D Overall height (to top of cab)		10'6" {3,200}	
E Ground clearance of rear end*		3'11" {1,200}	
F Ground clearance*		19'3" {490}	

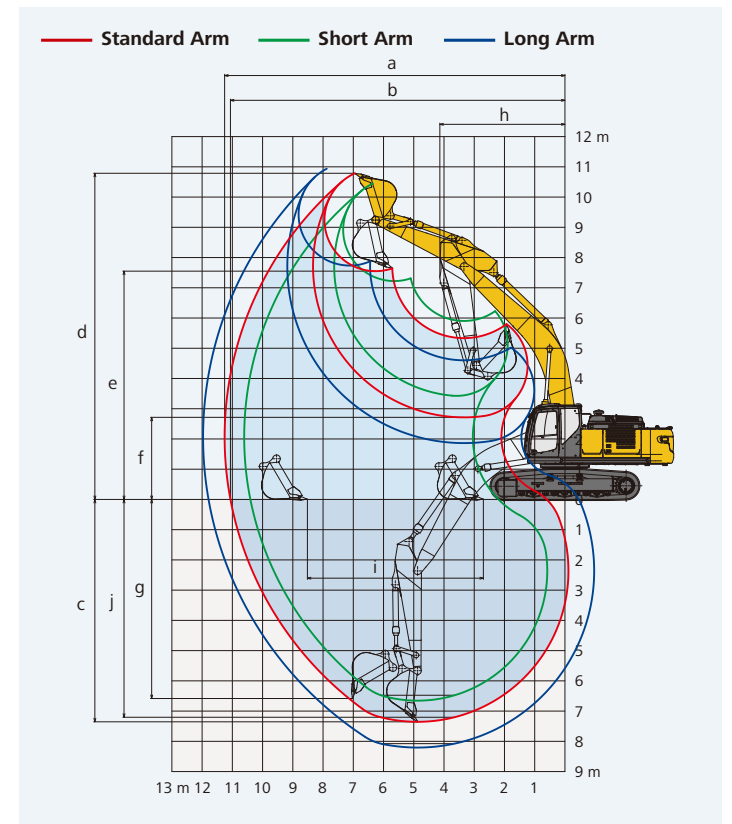

G Tail swing radius	11'10" {3,600}
G' Distance from center of swing to rear end	11'10" {3,600}
H Tumbler distance	13'3" {4,050}
I Overall length of crawler	16'3" {4,960}
J Track gauge	8'6" {2,590}
K Shoe width	31.5" {800}/35.4" {900}
L Overall width of upperstructure	10'3" {3,120}

*Without including height of shoe lug. **Shoe width: 31.5" {800 mm}

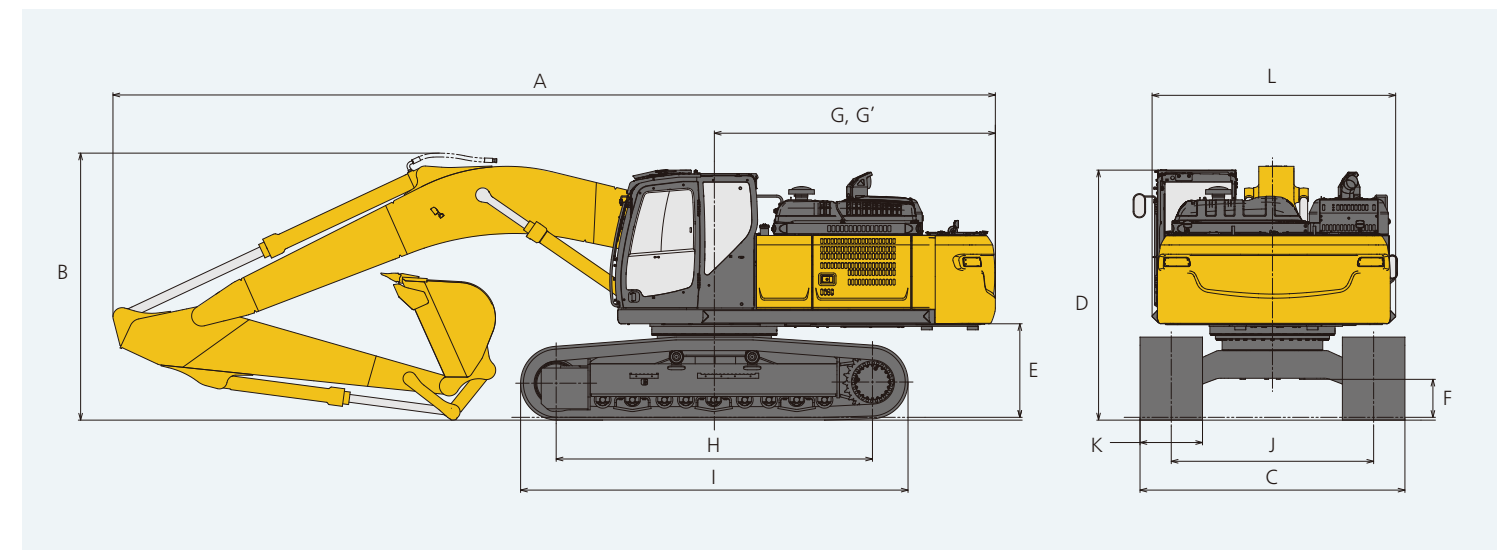

HIGH & WIDE

The High & Wide Specification is specially equipped for forestry and hilly terrain work. The High & Wide Specification has the generous ground clearance needed to penetrate sites littered with stumps or rocks. The extra crawler width ensures excellent stability, contributing to uninterrupted working and greater lifting capacity. Durability is significantly improved with full track guides and larger upper rollers for the crawlers, to prevent de-tracking. With double grouser shoes used for better grip, these machines are designed to work smoothly over the roughest ground.



Performance

Excellent Stability

Overall width of crawlers is greater than standard models, for dependable stability and improved lifting capacity.

Generous ground clearance

Increased ground clearance over standard models for navigating rocky, forestry and swampy terrain.



Overall width of crawlers **12'0" {3,650 mm}**



Ground clearance **30.9" {785 mm}**

Durability

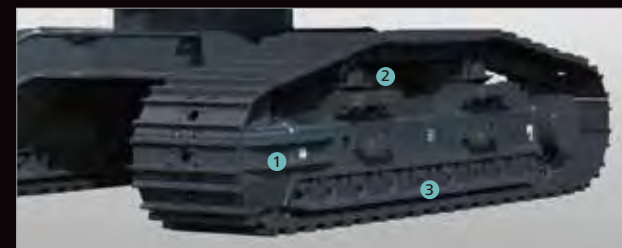

Unbeatable durability

The crawlers are designed to provide unbeatable durability to take on the harshest terrain. They feature full track guides to eliminate de-tracking concerns, a reinforced guide frame built to withstand heavy impact, and large, double-support, outer flanged upper rollers unfazed by powerful vibrations.



1 Reinforced guide frame



2 Large, double-support, outer flanged upper rollers



3 Heavy duty shoe (700 mm double bar grouser)



3 Full track guide

Operating Weight & Ground Pressure

In standard trim, with Standard boom, 13'7" {4.15 m} arm, and 1.57 cu.yd. {1.20 m³} ISO heaped bucket

Shaped		Double grouser shoes (even height)	Triple grouser shoes (even height)	
Shoe width	ft-in {mm}	27.6" {700}	27.6" {700}	31.5" {800}
Overall width of crawler	ft-in {mm}	12'0" {3,650}	12'0" {3,650}	12'4" {3,750}
Ground pressure	psi {kPa}	9.0 {62}	8.9 {61}	7.9 {54}
Operating weight	lb {kg}	85,100 {38,600}	84,000 {38,100}	85,100 {38,600}

Working Ranges

Unit: ft-in {m}

Range	Arm	21'4" {6.50 m}		
		Short 8'6" {2.60m}	Standard 10'10" {3.30m}	Long 13'7" {4.15m}
a- Max. digging reach		34'10" {10.61}	36'11" {11.26}	39'3" {11.97}
b- Max. digging reach at ground level		33'11" {10.34}	36'1" {11.00}	38'6" {11.73}
c- Max. digging depth		20'10" {6.34}	23'1" {7.04}	25'11" {7.89}
d- Max. digging height		35'4" {10.76}	36'5" {11.10}	36'11" {11.25}
e- Max. dumping clearance		24'9" {7.54}	25'10" {7.87}	26'5" {8.05}
f- Min. dumping clearance		12'3" {3.74}	9'11" {3.03}	7'2" {2.18}
g- Max. vertical wall digging depth		18'1" {5.52}	20'7" {6.27}	22'9" {6.94}
h- Min. front swing radius		14'1" {4.28}	13'7" {4.14}	13'11" {4.25}
i- Min. front swing length		14'1" {4.28}	13'7" {4.14}	13'11" {4.24}
j- Height at min. swing radius		30'1" {9.18}	29'9" {9.06}	29'9" {9.08}
k- Digging depth for 8' {2.4 m} flat bottom		20'3" {6.16}	22'7" {6.89}	25'6" {7.76}
l- Horizontal digging stroke at ground level	stroke	13'11" {4.24}	19'3" {5.87}	23'11" {7.28}
	min.	11'10" {3.60}	8'7" {2.62}	6'3" {1.91}
Bucket capacity SAE heaped cu.yd. {m ³ }		2.09 {1.60}	1.83 {1.40}	1.57 {1.20}

Digging Force (ISO 6015)

Unit: lb {kN}

Arm length		Short 8'6" {2.60m}	Standard 10'10" {3.30m}	Long 13'7" {4.15m}
		Bucket digging force	SAE	45,900 {204}
	ISO	51,000 {227}	56,200 {250}*	
Arm crowding force	SAE	44,100 {196}	37,100 {160}	30,800 {137}
	ISO	48,600 {216}*	39,600 {176}*	33,700 {150}*
	SAE	45,900 {204}	37,100 {165}	31,500 {140}
	ISO	50,600 {225}*	40,700 {181}*	34,600 {154}*

*Power Boost engaged.

Dimensions

Unit: ft-in {mm}

Arm length	Short 8'6" {2.60m}	Standard 10'10" {3.30m}	Long 13'7" {4.15m}
A Overall length	37'3" {11,360}	36'8" {11,180}	36'9" {11,210}
B Overall height (to top of boom)*	12'5" {3,780}	11'3" {3,420}	11'5" {3,480}
C Overall width**		12'0" {3,650}	
D Overall height (to top of cab)*		11'7" {3,520}	
E Ground clearance of rear end*		4'11" {1,510}	
F Ground clearance*		30.9" {785}	

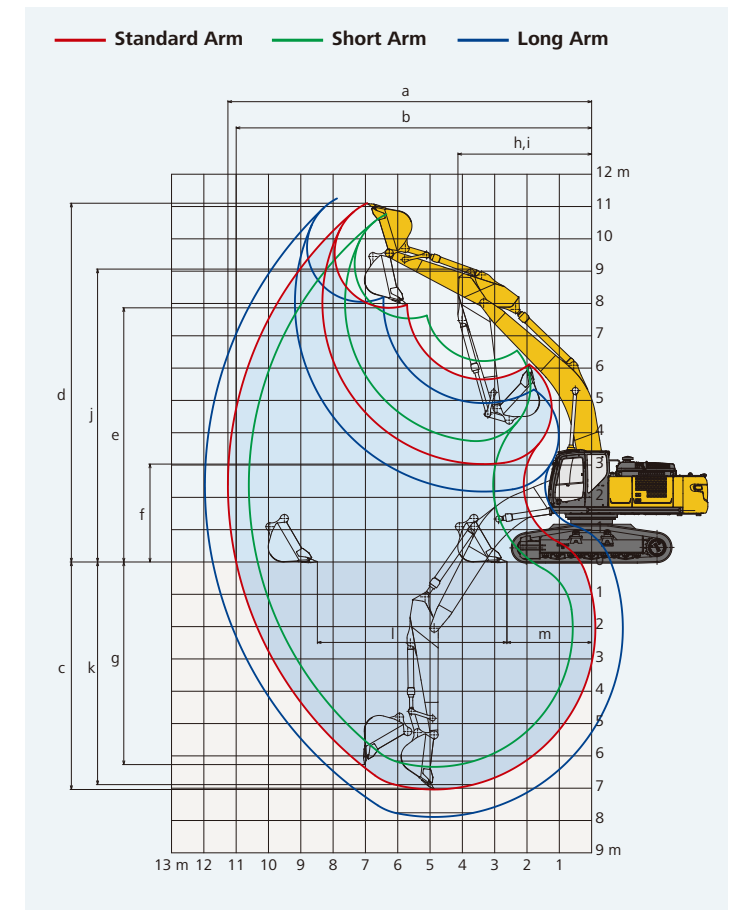

G Tail swing radius	11'10" {3,600}
G' Distance from center of swing to rear end	11'10" {3,600}
H Tumbler distance	13'3" {4,050}
I Overall length of crawler	16'4" {4,980}
J Track gauge	9'8" {2,950}
K Shoe width	27.6" {700}/31.5" {800}
L Overall width of upperstructure	10'3" {3,120}

*Without including height of shoe lug. **Shoe width: 27.6" {700 mm}

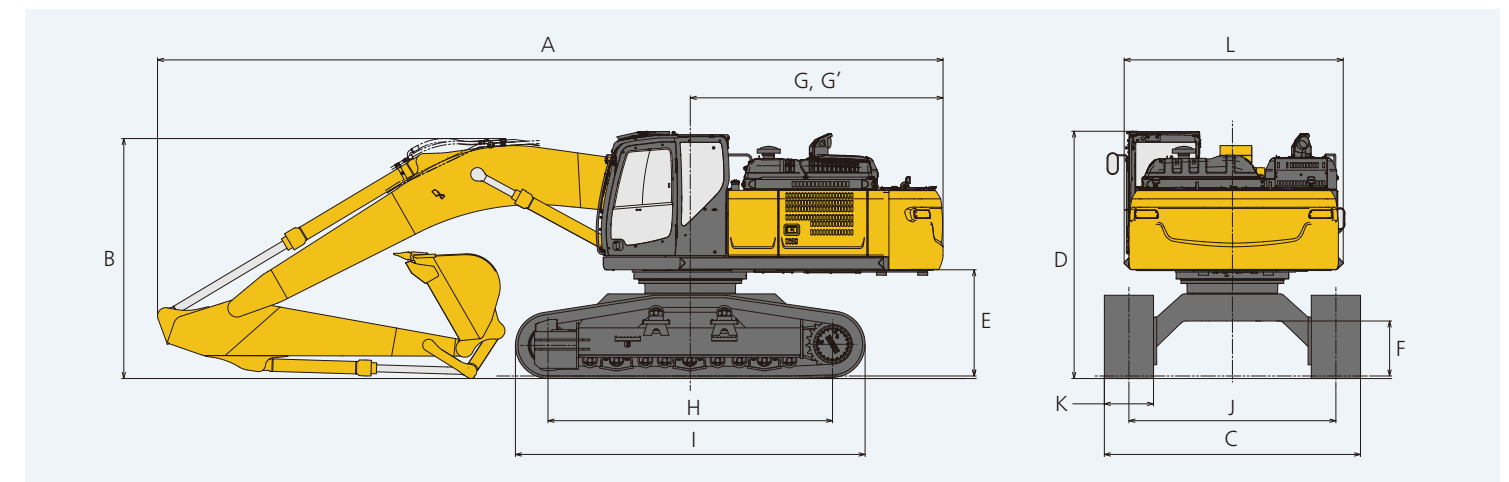

Lift Capacities

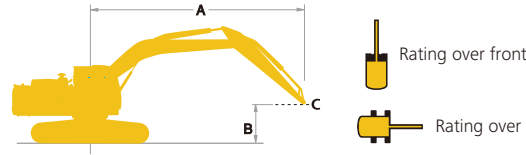

A - Reach from swing centerline to arm top
 B - Arm top height above/below ground
 C - Lift point (kg)
 Relief valve setting: 4,970 psi [34.3 MPa]
 Relief valve setting (Heavy Lift): 5,480 psi [37.8 MPa]

STANDARD MACHINE

SK350LC Short arm		Boom: 21'4" {6.50 m} Arm: 8'6" {2.60 m} Without bucket: Counterweight: 19,010 lb {8,620 kg} Shoe: 31.5" {800 mm} (Heavy Lift)										
A		10' {3.0 m}		15' {4.6 m}		20' {6.1 m}		25' {7.6 m}		At max. reach		Radius
		Bucket	Pin	Bucket	Pin	Bucket	Pin	Bucket	Pin	Bucket	Pin	
B	25' {7.6 m}	lb (kg)										
	20' {6.1 m}	lb (kg)										
	15' {4.6 m}	lb (kg)										
	10' {3.0 m}	lb (kg)										
	5' {1.5 m}	lb (kg)										
	G.L.	lb (kg)										
	-5' (-1.5 m)	lb (kg)										
	-10' (-3.0 m)	lb (kg)										
-15' (-4.6 m)	lb (kg)											

SK350LC Standard arm		Boom: 21'4" {6.50 m} Arm: 10'10" {3.30 m} Without bucket: Counterweight: 19,010 lb {8,620 kg} Shoe: 31.5" {800 mm} (Heavy Lift)												
A		10' {3.0 m}		15' {4.6 m}		20' {6.1 m}		25' {7.6 m}		30' {9.1 m}		At max. reach		Radius
		Bucket	Pin	Bucket	Pin	Bucket	Pin	Bucket	Pin	Bucket	Pin	Bucket	Pin	
B	30' {9.1 m}	lb (kg)												
	25' {7.6 m}	lb (kg)												
	20' {6.1 m}	lb (kg)												
	15' {4.6 m}	lb (kg)												
	10' {3.0 m}	lb (kg)												
	5' {1.5 m}	lb (kg)												
	G.L.	lb (kg)												
	-5' (-1.5 m)	lb (kg)												
-10' (-3.0 m)	lb (kg)													
-15' (-4.6 m)	lb (kg)													

SK350LC Long arm		Boom: 21'4" {6.50 m} Arm: 13'7" {4.15 m} Without bucket: Counterweight: 19,010 lb {8,620 kg} Shoe: 31.5" {800 mm} (Heavy Lift)														
A		5' {1.5 m}		10' {3.0 m}		15' {4.6 m}		20' {6.1 m}		25' {7.6 m}		30' {9.1 m}		At max. reach		Radius
		Bucket	Pin	Bucket	Pin	Bucket	Pin	Bucket	Pin	Bucket	Pin	Bucket	Pin			
B	30' {9.1 m}	lb (kg)														
	25' {7.6 m}	lb (kg)														
	20' {6.1 m}	lb (kg)														
	15' {4.6 m}	lb (kg)														
	10' {3.0 m}	lb (kg)														
	5' {1.5 m}	lb (kg)														
	G.L.	lb (kg)														
	-5' (-1.5 m)	lb (kg)														
-10' (-3.0 m)	lb (kg)															
-15' (-4.6 m)	lb (kg)															
-20' (-6.1 m)	lb (kg)															

HIGH AND WIDE

SK390LC Short arm		Boom: 21'4" {6.50 m} Arm: 8'6" {2.60 m} Without bucket: Counterweight: 16,780 lb {7,610 kg} Shoe: 27.6" {700mm} (Heavy Lift)										
A		10' {3.0 m}		15' {4.6 m}		20' {6.1 m}		25' {7.6 m}		At max. reach		Radius
		Bucket	Pin	Bucket	Pin	Bucket	Pin	Bucket	Pin	Bucket	Pin	
B	30' {9.1 m}	lb (kg)										
	25' {7.6 m}	lb (kg)										
	20' {6.1 m}	lb (kg)										
	15' {4.6 m}	lb (kg)										
	10' {3.0 m}	lb (kg)										
	5' {1.5 m}	lb (kg)										
	G.L.	lb (kg)										
	-5' (-1.5 m)	lb (kg)										
-10' (-3.0 m)	lb (kg)											
-15' (-4.6 m)	lb (kg)											

SK390LC Standard arm		Boom: 21'4" {6.50 m} Arm: 10'10" {3.30 m} Without bucket: Counterweight: 16,780 lb {7,610 kg} Shoe: 27.6" {700mm} (Heavy Lift)												
A		10' {3.0 m}		15' {4.6 m}		20' {6.1 m}		25' {7.6 m}		30' {9.1 m}		At max. reach		Radius
		Bucket	Pin	Bucket	Pin	Bucket	Pin	Bucket	Pin	Bucket	Pin	Bucket	Pin	
B	30' {9.1 m}	lb (kg)												
	25' {7.6 m}	lb (kg)												
	20' {6.1 m}	lb (kg)												
	15' {4.6 m}	lb (kg)												
	10' {3.0 m}	lb (kg)												
	5' {1.5 m}	lb (kg)												
	G.L.	lb (kg)												
	-5' (-1.5 m)	lb (kg)												
-10' (-3.0 m)	lb (kg)													
-15' (-4.6 m)	lb (kg)													

SK390LC Long arm		Boom: 21'4" {6.50 m} Arm: 13'7" {4.15 m} Without bucket: Counterweight: 16,780 lb {7,610 kg} Shoe: 27.6" {700mm} (Heavy Lift)														
A		5' {1.5 m}		10' {3.0 m}		15' {4.6 m}		20' {6.1 m}		25' {7.6 m}		30' {9.1 m}		At max. reach		Radius
		Bucket	Pin	Bucket	Pin	Bucket	Pin	Bucket	Pin	Bucket	Pin	Bucket	Pin			
B	30' {9.1 m}	lb (kg)														
	25' {7.6 m}	lb (kg)														
	20' {6.1 m}	lb (kg)														
	15' {4.6 m}	lb (kg)														
	10' {3.0 m}	lb (kg)														
	5' {1.5 m}	lb (kg)														
	G.L.	lb (kg)														
	-5' (-1.5 m)	lb (kg)														
-10' (-3.0 m)	lb (kg)															
-15' (-4.6 m)	lb (kg)															
-20' (-6.1 m)	lb (kg)															

- Note:
- Do not attempt to lift or hold any load that is greater than these lift capacities at their specified lift point radius and heights. Weight of all accessories must be deducted from the above lift capacities.
 - Lift capacities are based on machine standing on level, firm, and uniform ground. User must make allowance for job conditions such as soft or uneven ground, out of level conditions, side loads, sudden stopping of loads, hazardous conditions, experience of personnel, etc.
 - Bucket pin attachment point defined as lift point.
 - The above lift capacities are in compliance with ISO 10567. They do not exceed 87% of hydraulic lift capacity or 75% of tipping load. Lift capacities marked with an asterisk(*) are limited by hydraulic capacity rather than tipping load.
 - Operator should be fully acquainted with the Operator's and Maintenance Instructions before operating this machine. Rules for safe operation of equipment should be adhered to at all times.
 - Lift capacities apply to only machine as originally manufactured and normally equipped by KOBELCO CONSTRUCTION MACHINERY CO., LTD.